

**EPSON<sup>®</sup>**

# **DS-790WN User's Guide**



---

# Contents

<b>DS-790WN User's Guide .....</b>	<b>9</b>
<b>Product Basics .....</b>	<b>10</b>
Using the Control Panel .....	10
Control Panel Buttons and Lights .....	11
LCD Screen .....	11
Status Icon Information.....	12
Navigating the LCD Screen .....	13
Entering Characters on the LCD Screen .....	14
Viewing Animations .....	15
Adjusting the Screen Brightness .....	16
Adjusting Control Panel Sounds.....	16
Changing LCD Screen Language .....	16
Selecting the Date and Time .....	17
Changing the Keyboard Layout.....	17
Adjusting the Operation Time Out Setting .....	18
Preventing PC Connection via USB .....	18
Setting Direct Power On.....	19
Customizing the Control Panel Display .....	19
Registering Presets .....	19
Customizing the Home Screen .....	22
Changing Regular Cleaning Alert Settings .....	24
Changing Roller Replacement Alert Settings .....	25
Setting a Password and Locking the Control Panel.....	25
Setting Up Epson Connect Services .....	27
Product Parts Locations .....	27
Product Parts.....	28
User Replaceable Epson Product Parts .....	31
Using Power Saving Settings .....	32
Changing the Sleep Timer Settings .....	32
Changing the Power Off Timer Settings .....	33

Using the Epson Smart Panel Mobile App.....	33
<b>Loading Originals .....</b>	<b>34</b>
Loading Originals in the Input Tray.....	34
Loading Multiple Sizes of Originals in the Input Tray .....	42
Original Document Specifications.....	45
Loading Plastic and Laminated Cards in the Input Tray .....	49
Plastic and Laminated Card Specifications .....	53
Loading Special Originals.....	54
Special Original Specifications .....	61
<b>Wi-Fi or Wired Networking.....</b>	<b>63</b>
Network Security Recommendations .....	63
Connecting to an Existing Wi-Fi Network .....	64
Selecting Wireless Network Settings from the Control Panel .....	65
Wi-Fi Direct (Simple AP) Mode Setup .....	67
Connecting to a Mobile Device .....	68
Modifying the Wi-Fi Direct Network Name or Password .....	68
Setting Up Wireless Scanning from a Smart Device Using Epson Smart Panel .....	69
Wi-Fi Protected Setup (WPS).....	71
Using WPS to Connect to a Network.....	71
Using WPS PIN Mode to Connect to a Network .....	72
Setting Up Network Scanning .....	72
Determining the Product's IP Address .....	75
Configuring Email Server Settings.....	75
Email Server Settings .....	77
Setting Up a Shared Network Folder .....	78
Creating a Shared Network Folder .....	78
Registering Contacts for Email, Network, or FTP Scanning - Control Panel.....	80
Registering Contacts for Email, Network, or FTP Scanning - Web Config.....	81
Changing or Updating Network Connections .....	83
Accessing the Web Config Utility.....	83
Changing a USB Connection to a Wi-Fi Connection.....	84
Changing a Wi-Fi Connection to a Wired Network Connection.....	84
Connecting to a New Wi-Fi Router .....	85

Disabling Wi-Fi Features .....	85
<b>Scanning .....</b>	<b>86</b>
Starting a Scan.....	86
Starting a Scan Using the Product Control Panel .....	86
Scanning to a Connected Computer .....	87
Scanning to an Email .....	89
Scanning to a Network Folder or FTP Server.....	90
Scanning to the Cloud.....	91
Scanning to an External USB Device.....	92
Setting Up a WSD Port (Windows 7).....	93
Scanning Using WSD - Windows.....	94
Scanning Using Presets.....	94
Adding and Assigning Scan Jobs with Document Capture Pro - Windows .....	95
Adding and Assigning Scan Jobs with Document Capture - Mac.....	98
Starting a Scan Using the Epson Scan 2 Icon .....	99
Starting a Scan from a Scanning Program.....	101
Starting a Scan from a Smartphone or Tablet.....	103
Scanning with Document Capture Pro or Document Capture.....	103
Setting the Operation Mode on the Product Control Panel.....	103
Scanning with Simple Scan in Document Capture Pro - Windows.....	104
Scanning with Job Scan in Document Capture Pro - Windows .....	106
Scanning with Document Capture - Mac.....	107
Scanning in Epson Scan 2.....	110
Additional Scanning Settings - Main Settings Tab.....	114
Additional Scanning Settings - Advanced Settings Tab .....	115
Scanning Settings for Special Documents .....	116
Saving Scanned Documents as a Searchable PDF Using Epson Scan 2.....	117
Image Format Options .....	118
Scan Resolution Guidelines .....	119
Scanning Special Projects.....	120
Scanning Two Originals onto One Sheet (Stitching Images) - Windows.....	120
Scanning Multi-Page Originals as Separate Files - Windows .....	123
Saving a Scan as an Office Format File - Windows .....	126

Scanning to a SharePoint Server or Cloud Service - Windows .....	128
Scanning to a SharePoint Server or Cloud Service - Mac .....	130
Scanning with AirPrint .....	131
Authentication Scanning.....	132
<b>Cleaning and Transporting Your Product .....</b>	<b>134</b>
Cleaning Your Product .....	134
Cleaning Inside Your Product.....	134
Checking the Roller Counter .....	146
Replacing the Rollers .....	148
Resetting the Roller Counter .....	154
Transporting Your Product .....	154
<b>Solving Problems .....</b>	<b>157</b>
Product Status Messages .....	157
Solving Scanning Problems .....	160
Product Does Not Turn On or Turns Off Unexpectedly.....	160
Forgot the Administrator Password .....	160
Scanner Button Does Not Work as Expected .....	161
Scanning Software Does Not Operate Correctly .....	161
Paper Feeding Problems.....	163
Paper Jam Problems .....	163
Paper Protection Does Not Work Correctly .....	166
Scanning is Slow .....	166
Cannot Send Scans to a Cloud Service.....	167
Cannot Send Scans to an Email .....	167
Solving Network Scanning Problems .....	167
Product Cannot Connect to a Wireless Router or Access Point .....	168
Network Software Cannot Find Product on a Network.....	169
Wired Network Connection Becomes Unstable .....	170
Cannot Scan Over a Network .....	171
Cannot Save a Scan to a Shared Folder Over a Network.....	172
Solving Scanned Image Quality Problems .....	173
Back of Original Image Appears in Scanned Image .....	173
Scanned Characters are Blurry .....	174

Characters are not Recognized During Conversion to Editable Text (OCR) .....	175
Ripple Patterns Appear in an Image .....	175
Spots or Lines Appear in All Scanned Images .....	176
Scanned Image is Cropped .....	176
Resetting the Epson Scan 2 Settings .....	177
Uninstall Your Product Software.....	177
Uninstalling Product Software - Windows .....	178
Uninstalling Product Software - Mac.....	178
Where to Get Help (U.S. and Canada) .....	179
Where to Get Help (Latin America).....	180
<b>Technical Specifications .....</b>	<b>182</b>
Windows System Requirements .....	182
Mac System Requirements .....	182
General Specifications .....	183
Dimension Specifications .....	184
Electrical Specifications .....	185
Environmental Specifications .....	186
Network Interface Specifications .....	186
Safety and Approvals Specifications .....	188
<b>Notices .....</b>	<b>191</b>
Important Safety Instructions.....	191
Restrictions on Copying .....	194
Default Delay Times for Power Management for Epson Products.....	194
Binding Arbitration and Class Waiver .....	195
Trademarks .....	198
Copyright Notice.....	198
libTIFF Software Acknowledgment.....	199
A Note Concerning Responsible Use of Copyrighted Materials.....	199
Copyright Attribution .....	200





---

# DS-790WN User's Guide

Welcome to the DS-790WN *User's Guide*.

For a printable PDF copy of this guide, [click here](#).

---

## Product Basics

See these sections to learn about the basic features of your product.

- [Using the Control Panel](#)
- [Adjusting the Screen Brightness](#)
- [Adjusting Control Panel Sounds](#)
- [Changing LCD Screen Language](#)
- [Selecting the Date and Time](#)
- [Changing the Keyboard Layout](#)
- [Adjusting the Operation Time Out Setting](#)
- [Preventing PC Connection via USB](#)
- [Setting Direct Power On](#)
- [Customizing the Control Panel Display](#)
- [Changing Regular Cleaning Alert Settings](#)
- [Changing Roller Replacement Alert Settings](#)
- [Setting a Password and Locking the Control Panel](#)
- [Setting Up Epson Connect Services](#)
- [Product Parts Locations](#)
- [User Replaceable Epson Product Parts](#)
- [Using Power Saving Settings](#)
- [Using the Epson Smart Panel Mobile App](#)

## Using the Control Panel



See these sections to learn about the control panel and select control panel settings.

- [Control Panel Buttons and Lights](#)
- [LCD Screen](#)
- [Status Icon Information](#)
- [Navigating the LCD Screen](#)
- [Entering Characters on the LCD Screen](#)
- [Viewing Animations](#)

**Parent topic:** [Product Basics](#)

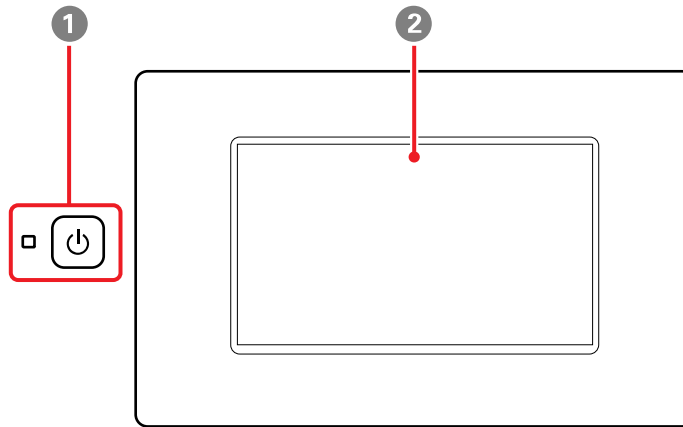
## Control Panel Buttons and Lights



- 1  power button and the  power light
- 2 LCD screen

Parent topic: [Using the Control Panel](#)

## LCD Screen

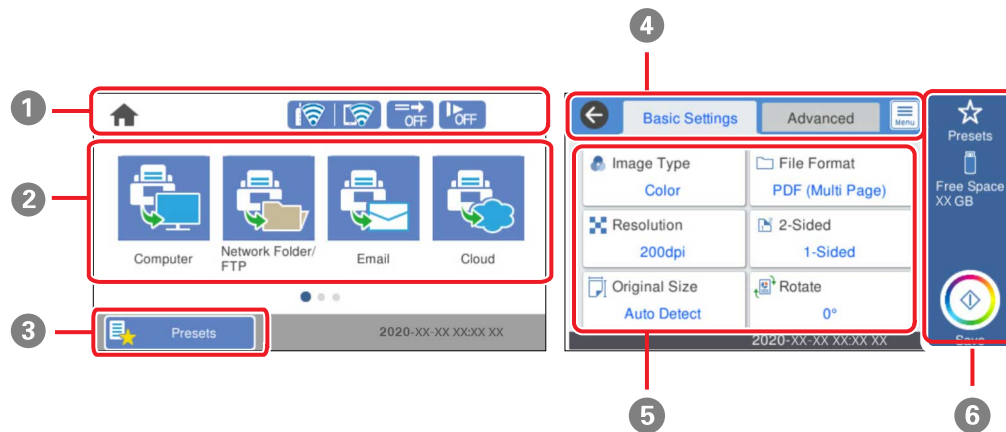



















- 1 Displays various status information; select an icon to check its status or adjust its settings
- 2 Menu options
- 3 Displays the presets list; load your presets and register new presets
- 4 Select a tab to view different options and settings
- 5 Setting options
- 6 Select to perform an action

Parent topic: [Using the Control Panel](#)

## Status Icon Information

Your product displays status icons on the LCD screen for certain product status conditions.

Icons	Description
	Displays the home screen.
	Returns to the home screen.
	<p>Displays the network connection status; select the icon to set up or change your network connection.</p> <ul style="list-style-type: none"> <li>•  The product is not connected to a wired (Ethernet) network.</li> <li>•  The product is connected to a wired (Ethernet) network.</li> <li>•  The product is not connected to a wireless network.</li> <li>•  The product is searching for an SSID or experiencing a wireless network connection issue.</li> <li>•  The product is connected to a wireless network; the number of bars indicates the connection's signal strength.</li> <li>•  Wi-Fi Direct is not enabled.</li> <li>•  Wi-Fi Direct is enabled.</li> </ul>
	<p>The <b>DFDS Function</b> (Double Feed Detection Skip Function) is enabled or disabled. Select the icon to change the setting.</p> <p>This function skips double feed detection once and continues scanning. Enable <b>DFDS Function</b> to scan originals (plastic cards or envelopes) that are detected as double feeds.</p>

Icons	Description
	The <b>Slow</b> function is enabled or disabled. Select the icon to change the setting. This function slows down the scanning speed. Enable this function to scan originals (such as thin paper) that are likely to jam.
	Indicates that the user restriction feature is enabled. You need to select a user name and then enter a password. Contact your administrator for login information. When enabled, a user with access permission has logged in. Select the icon to logout.
	Displays the previous screen.
	Indicates that the settings have been changed from the user default or the factory default.
	Displays additional information or instructions; select the icon to display the information.
	There is a problem with the indicated setting; select the icon for information on resolving the problem.
	May appear when the authentication function is enabled. You can change the password or the ID number of your authenticated account.

**Parent topic:** [Using the Control Panel](#)

**Related concepts**

[Authentication Scanning](#)

**Related tasks**

[Setting a Password and Locking the Control Panel](#)

## Navigating the LCD Screen

Follow these guidelines to navigate and use the menus on the LCD screen.

 Tap or press the screen to select an item or icon

 Flick the screen to scroll swiftly

 Slide your finger across the screen to move items

To change a setting, tap anywhere on the setting.

To enter a value in a field, tap the field to display the on-screen keyboard.

**Parent topic:** [Using the Control Panel](#)

## Entering Characters on the LCD Screen

Follow these guidelines to enter characters for passwords and other settings.

### On-screen keyboard

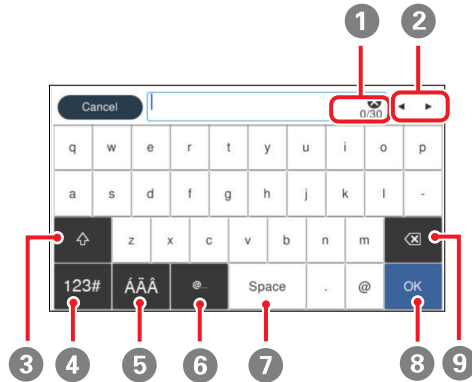

- 1 Displays the character count
- 2 Moves the cursor left or right
- 3 Switches between uppercase and lowercase characters
- 4 Switches between characters and numbers or symbols
- 5 Switches the character type
- 6 Displays a list of common domain names to choose from
- 7 Enters a space
- 8 Select when you are finished
- 9 Deletes the previous character

**Parent topic:** [Using the Control Panel](#)

## Viewing Animations

You can view animations on the LCD screen to help guide you with a procedure or to troubleshoot a problem.

1. Select **Help** on the home screen.
2. Select **Troubleshooting** if you are experiencing a problem or **How To** to view instructions on common procedures.
3. Select a topic from the list of available topics and follow the on-screen instructions.

While viewing the topics, you may see screens like this:

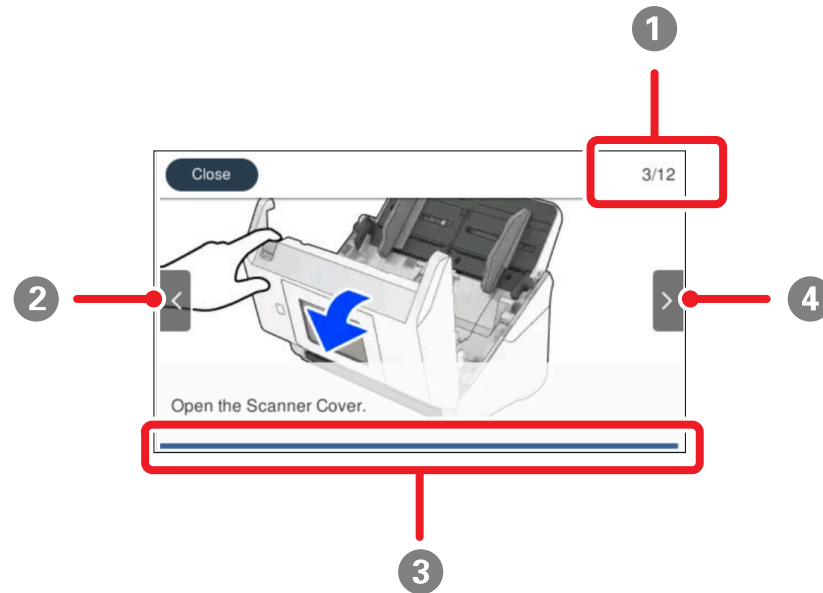



- 1 Displays the current step number and the total number of steps
- 2 Select the left arrow to view the previous step
- 3 Indicates your overall progress through the animation
- 4 Select the right arrow to view the next step

**Parent topic:** [Using the Control Panel](#)

## Adjusting the Screen Brightness



You can adjust the brightness of the LCD screen.

1. Select the  home icon, if necessary.
2. Select **Settings** > **Basic Settings**.
3. Select **LCD Brightness**.
4. Select the – or + icon to decrease or increase the brightness.
5. Select **OK** to exit.
6. Select the  return home icon to return to the home screen.

Parent topic: [Product Basics](#)

## Adjusting Control Panel Sounds

You can adjust the sound level heard when you press buttons on the control panel.

1. Select the  home icon, if necessary.
2. Select **Settings** > **Basic Settings**.
3. Select **Sounds**.
4. Do one of the following:
  - To mute all control panel sounds, turn the **Button Press** setting off.
  - To adjust the sound level for scanner errors, select **Error Tone** and tap the icons to select the desired level.
5. Select **OK** to exit.
6. Select the  return home icon to return to the home screen.

Parent topic: [Product Basics](#)

## Changing LCD Screen Language

You can change the language used on the LCD screen.

1. Select the  home icon, if necessary.
2. Select **Settings** > **Basic Settings**.
3. Scroll down and select **Language**.
4. Select a language.



5. Select the  return home icon to return to the home screen.

Parent topic: [Product Basics](#)

## Selecting the Date and Time

Select the current date, time, and daylight saving phase in your area, and choose your preferred date and time format.

1. Select the  home icon, if necessary.
2. Select **Settings** > **Basic Settings**.
3. Select **Date/Time Settings**.
4. Select **Daylight Saving Time**.
5. Select the setting that applies to your area:
  - **Off**: it is winter or your region does not use Daylight Saving Time (DST)
  - **Summer**: it is spring or summer and your region uses Daylight Saving Time (DST)



**Note:** If your region uses Daylight Saving Time (DST), you must change this setting to match the season. When you change from **Off** to **Summer**, your product automatically sets its clock ahead one hour. When you change from **Summer** to **Off**, it sets its clock back one hour.

6. Select **Date/Time**.
7. Select the date format you want to use.
8. Use the numeric keypad to enter the current date, then select **OK**.
9. Select the time format you want to use.
10. Use the numeric keypad to enter the current time, then select **OK**.
11. Select **Time Difference**.
12. Use the **+** and **-** buttons to enter the time difference between your time zone and UTC (Coordinated Universal Time), then select **OK**.
13. Select the  return home icon to return to the home screen.

Parent topic: [Product Basics](#)

## Changing the Keyboard Layout



You can change the layout of the keyboard on the control panel.

1. Select the  home icon, if necessary.
2. Select **Settings** > **Basic Settings**.
3. Select **Keyboard**.
4. Select the layout you want to use.
5. Select the  return home icon to return to the home screen.

**Parent topic:** [Product Basics](#)

## Adjusting the Operation Time Out Setting

The Operation Time Out setting causes the LCD screen to return to the home screen after a few minutes of inactivity. This feature is enabled by default, but you can turn it off.

1. Select the  home icon, if necessary.
2. Select **Settings** > **Basic Settings**.
3. Scroll down and select **Operation Time Out**.
4. Tap the setting to toggle it **On** or **Off** (**On** is the default).
5. If you want to increase or decrease the number of minutes, select **Time** and tap the **+** and **-** icons to set the desired number.
6. Select **OK** to exit.
7. Select the  return home icon to return to the home screen.

**Parent topic:** [Product Basics](#)

## Preventing PC Connection via USB

You can disable access to your product from a USB-connected computer. This restricts non-network access to the product.



1. Select the  home icon, if necessary.
2. Select **Settings** > **Basic Settings**.
3. Scroll down and select **PC Connection via USB**.
4. Select **Disable**.
5. Select **Yes** to restart the product.

**Parent topic:** [Product Basics](#)

## Setting Direct Power On

You can turn on the product directly when the product is connected to the power source, without pressing the power button.

**Note:** This setting can be locked by an administrator. If you cannot access or change this setting, contact your administrator for assistance.

1. Select the  home icon, if necessary.
2. Select **Settings** > **Basic Settings**.
3. Scroll down and select **Direct Power On**.
4. Select **On**.
5. Select the  return home icon to return to the home screen.

**Parent topic:** [Product Basics](#)

## Customizing the Control Panel Display

You can register up to 48 frequently used scanning settings as Presets and add the icon of the registered preset to the home screen. See these sections to learn about how to customize the control panel display.

[Registering Presets](#)

[Customizing the Home Screen](#)

**Parent topic:** [Product Basics](#)

## Registering Presets

You can register up to 48 frequently used scanning settings as presets.

**Note:** This setting can be locked by an administrator. If you cannot access or change this setting, contact your administrator for assistance. To register presets using Web Config, select **Presets** on the Scan tab and follow the instructions on the screen.

1. Select the  home icon, if necessary.

2. Select **Presets**.

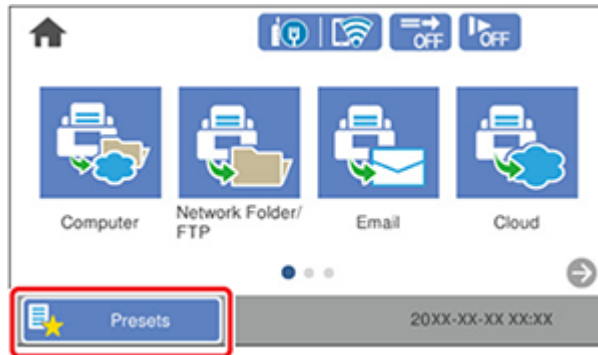

3. Select a **+** icon.



4. Select the scanning option you want to register as a preset.

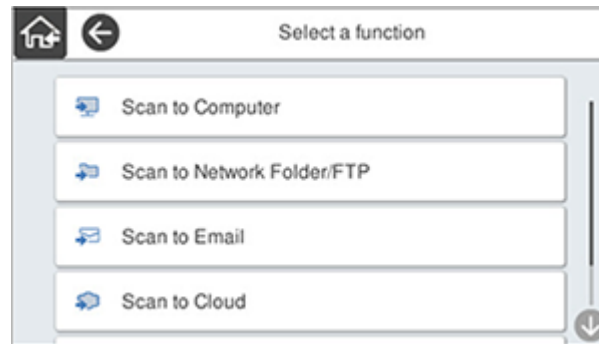

**Note:** For some scanning options, it is best to configure the destination information (such as email contacts or network folders) before registering the preset. You can still configure the destination information while registering the preset, but if it is configured beforehand, you can simply make your selections from the existing list.

**Note:** For the **Scan to Computer** option, select the computer on which Document Capture Pro is installed, and then select a registered job. This option is available only for a computer connected over a network.

5. Tap the  **Register** icon to register the preset.
6. Enter the following settings:
  - **Name:** Enter a name for the preset.
  - **Set Icon:** Select an icon and background color for the preset.
  - **Quick Send Setting:** Select **On** to start scanning immediately when the preset is selected.

**Note:** If you are using Document Capture Pro Server, the Quick Send preset takes priority over other software settings.

- **Contents:** Change scan settings as necessary.
7. Select **OK** to save the preset settings.
  8. Select the  return home icon to return to the home screen.

**Parent topic:** [Customizing the Control Panel Display](#)

## Related tasks

[Scanning Using Presets](#)

## Customizing the Home Screen

You can use the **Edit Home** option to customize the layout and appearance of the home screen and add icons to the presets.

**Note:** This setting can be locked by an administrator. If you cannot access or change this setting, contact your administrator for assistance.

1. Select the **🏠** home icon, if necessary.
2. Select **Settings > Edit Home**.
3. Choose from the following:
  - Select **Layout** to change the layout of the home screen.  
Select **Line** to display the icons in a horizontal line across the home screen.



Select **Matrix** to display the icons in a matrix on the home screen.



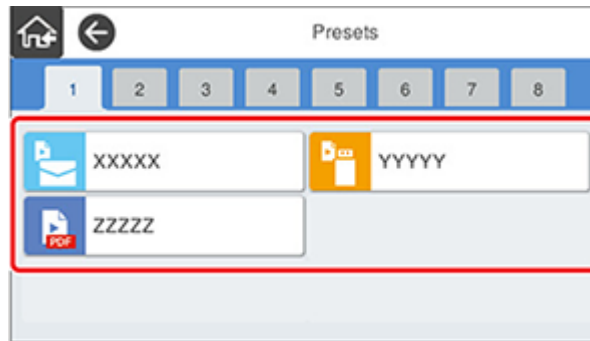

- Select **Add Icon** and choose **Function** to display icons for the default scanner functions, or **Presets** to select a preset icon to display on the home screen.

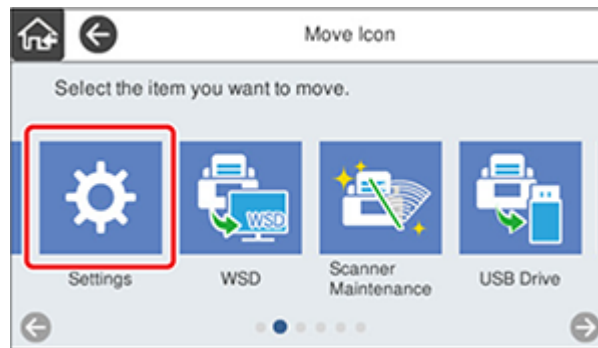
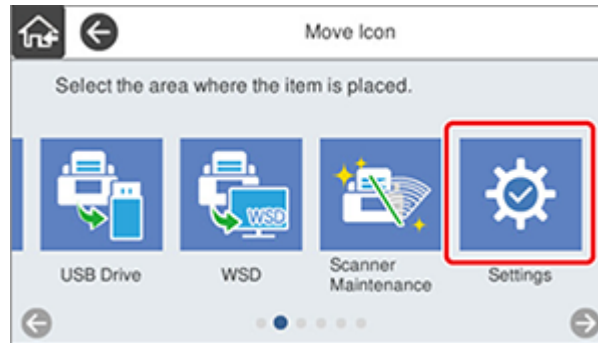

- Select **Remove Icon** and select the preset you want to remove from the home screen.

- Select **Move Icon** to reorder presets on the home screen. Select the icon you want to move, and then select the icon that is occupying the space you want to move the new icon to. The icons switch positions.



4. When you are finished customizing the home screen, select the  return home icon to return to the home screen and view your changes.



**Parent topic:** [Customizing the Control Panel Display](#)

## Changing Regular Cleaning Alert Settings

You can set an alert to appear to remind you to perform regular cleaning after a certain number of scans.

**Note:** This setting can be locked by an administrator. If you cannot access or change this setting, contact your administrator for assistance.





1. Select the  home icon, if necessary.
2. Select **Settings** > **Regular Cleaning Alert Settings**.
3. Do the following:
  - Set the **Warning Alert Setting** to **On** to receive a notification when it is time to clean inside the scanner.
  - On the **Count Alert Setting** screen, use the + and – icons to change the number of scans before the notification appears.
4. Select **OK** to exit.
5. Select the  return home icon to return to the home screen.

Parent topic: [Product Basics](#)

## Changing Roller Replacement Alert Settings

You can set an alert to appear to remind you to replace the roller after a certain number of scans.

**Note:** This setting can be locked by an administrator. If you cannot access or change this setting, contact your administrator for assistance.

1. Select the  home icon, if necessary.
2. Select **Settings** > **Roller Replacement Alert Setting**.
3. Select **Count Alert Setting**.
4. Use the + and – icons to change the number of scans (1,000 to 200,000) before the notification appears.
5. Select **OK** to exit.
6. Select the  return home icon to return to the home screen.

Parent topic: [Product Basics](#)

## Setting a Password and Locking the Control Panel

You can set an administrator password to lock the following settings and prevent them from being changed:

**Note:** You should set an administrator password and keep it in a safe place. You must know the administrator password in order to change it. If you forget the password or inadvertently set it, contact Epson for assistance.

- Scanner Settings
- Edit Home
- User Settings
- Network Settings
- Web Service Settings
- Contacts Manager
- System Administration
- Roller Replacement Alert Setting
- Regular Cleaning Alert Settings
- Reset the Number of Scans
- Change Settings

You can change the password using the product control panel.

**Note:** You can also change the password using Web Config or EpsonNet Config. See the online [Administrator's Guide](#) for more information.

1. Select the  home icon, if necessary.
2. Select **Settings**.
3. Select **System Administration**.
4. Select **Admin Settings**.
5. Select **Admin Password > Change**.
6. Enter your current password.

**Note:** The default password is the product's serial number. To locate the serial number, check the label attached to the back of your product. If you restore the product to default settings, the administrator password resets to the product serial number.

7. Enter a new password.

8. Enter the new password again to confirm it.

**Note:** Keep a copy of your password in a safe place.

9. Select **Lock Setting > On** to enable access restriction.

When the control panel is locked, you must enter the password to access any of the locked settings. You can reset the administrator password by selecting **Reset** on the Admin Password screen. To disable access restriction, select **Settings > System Administration > Admin Settings > Lock Setting > Off**.

**Parent topic:** [Product Basics](#)

## Setting Up Epson Connect Services

If you did not activate your product's email address for use with Epson Connect when you set up your product, you can activate it using the product control panel.

1. Select the  home icon, if necessary.
2. Select **Settings**.
3. Select **Web Service Settings**.
4. Select **Epson Connect Services**.
5. Select **Registration**.
6. Follow the instructions on the screen to activate your product's email address.

**Parent topic:** [Product Basics](#)

## Product Parts Locations

See these sections to identify the parts on your product.

[Product Parts](#)

**Parent topic:** [Product Basics](#)

## Product Parts

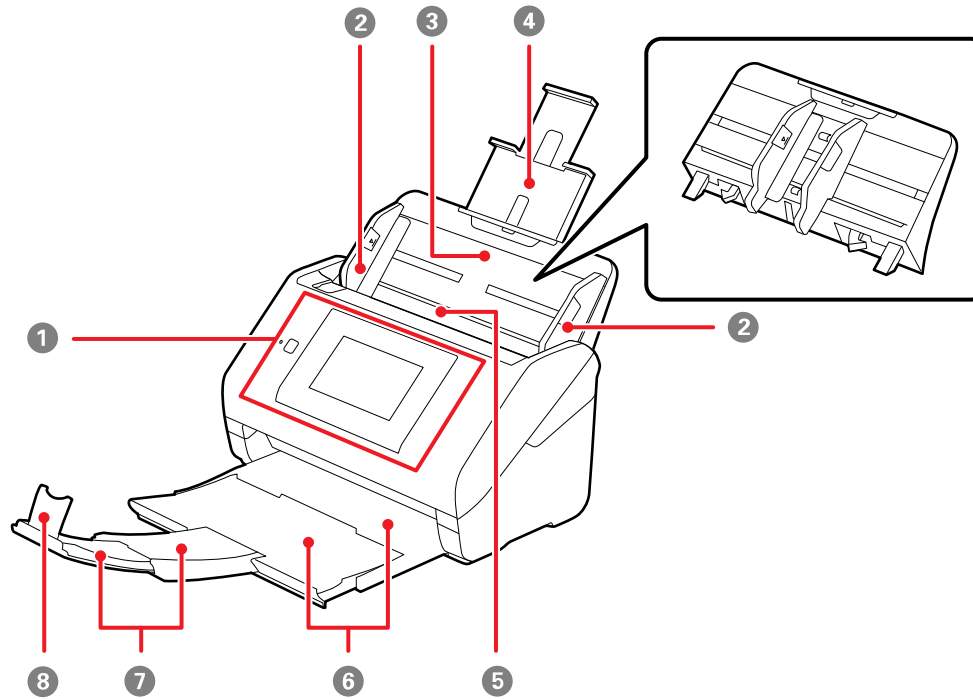

- 1 Control panel
- 2 Edge guides
- 3 Input tray
- 4 Input tray extension
- 5 ADF (Automatic Document Feeder)
- 6 Output tray
- 7 Output tray extensions
- 8 Paper tray

## 8 Stopper

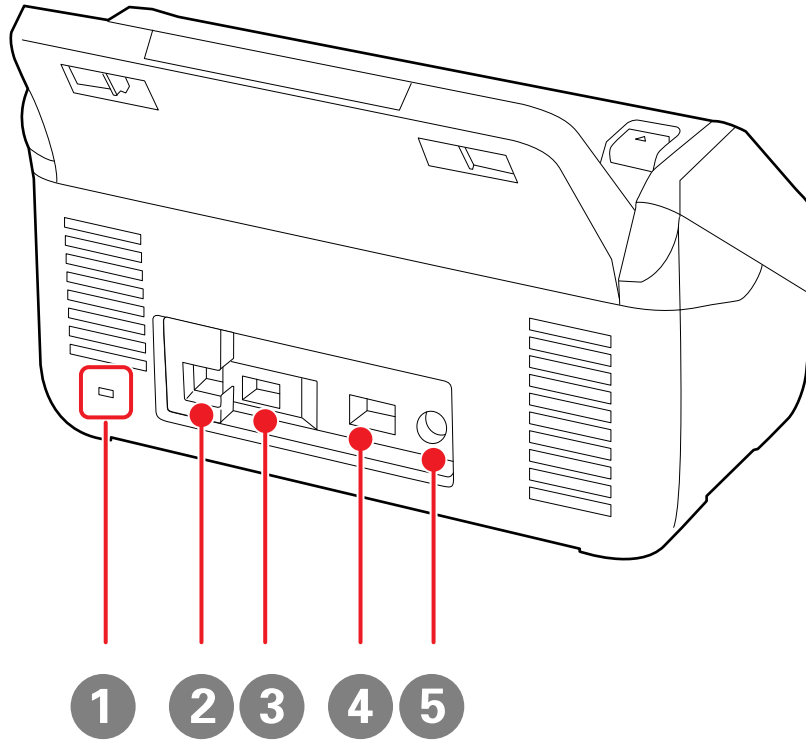

- 1 Kensington security slot
- 2 USB 3.0 port (Type B for computer)
- 3 External USB port (Type A for external USB device or IC card reader\*)
- 4 Ethernet (LAN) port
- 5 Power inlet

\* IC card reader is available only for authentication scanning using Document Capture Pro Server edition.

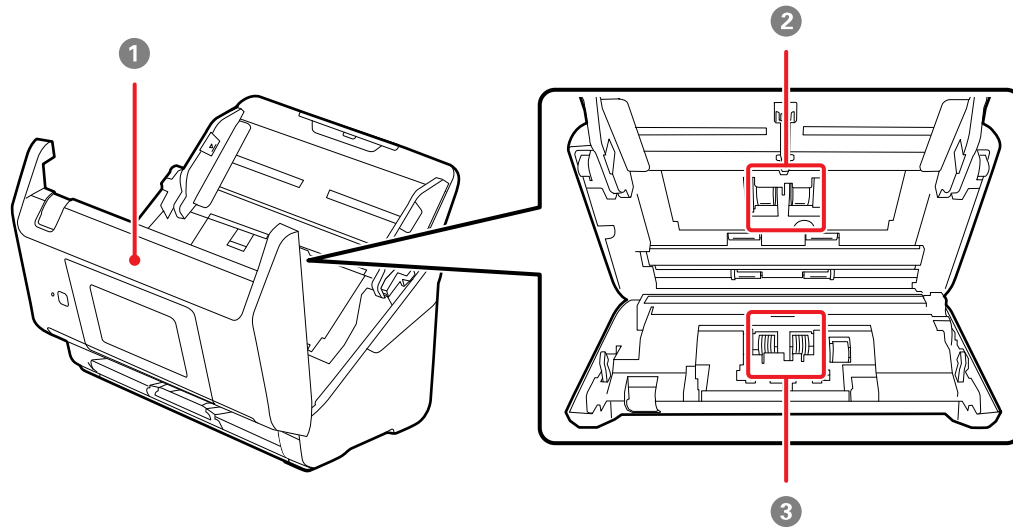

- 1 Scanner cover
- 2 Pickup rollers

### 3 Separation rollers

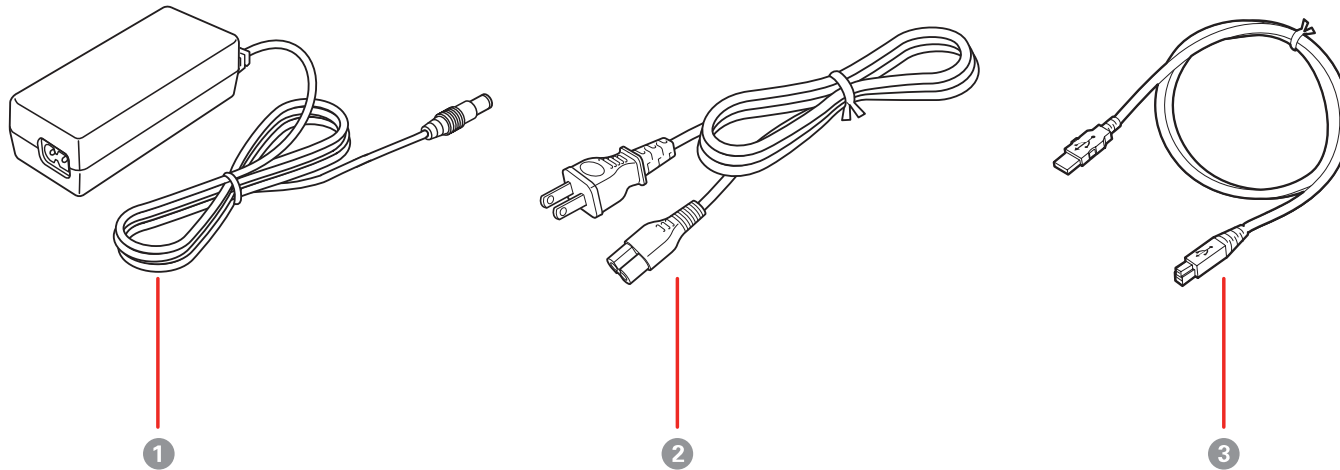

- 1 AC adapter
- 2 Power cord
- 3 USB 3.0 cable

Parent topic: [Product Parts Locations](#)

## User Replaceable Epson Product Parts

**U.S. and Canada:** You can purchase optional accessories and replacement parts at [epson.com](http://epson.com) (U.S. sales) or [epson.ca](http://epson.ca) (Canadian sales). You can also purchase accessories from an Epson authorized reseller. To find the nearest one, call 800-GO-EPSON (800-463-7766) in the U.S. or 800-807-7766 in Canada.

**Latin America:** You can purchase optional accessories and replacement parts from an Epson authorized reseller. To find the nearest reseller, go to [latin.epson.com](http://latin.epson.com). Or you can contact your nearest sales office as described in "Where to Get Help".

**Note:** Availability of accessories varies by country.

Part	Part number
Carrier sheet (5)	B12B819051
Roller assembly kit	B12B819671
Roller assembly kit 2	B12B819711
Cleaning kit	B12B819291
Paper alignment plate	B12B819691

**Parent topic:** [Product Basics](#)

## Using Power Saving Settings

Your product enters sleep mode automatically and turns off the LCD screen if it is not used for a period of time. You can make the time period shorter to save energy and resources.

[Changing the Sleep Timer Settings](#)

[Changing the Power Off Timer Settings](#)

**Parent topic:** [Product Basics](#)

## Changing the Sleep Timer Settings

You can adjust the time period before your product enters sleep mode and turns off the LCD screen.

1. Select the  home icon, if necessary.
2. Select **Settings** > **Basic Settings**.
3. Select **Sleep Timer**.
4. Select the **+** and **-** icons to increase or decrease the number of minutes.

**Note:** You can also press the minutes field and use the displayed numeric keypad to enter the number of minutes.



5. Select **OK** to exit.
6. Select the  return home icon to return to the home screen.

**Parent topic:** [Using Power Saving Settings](#)



## Changing the Power Off Timer Settings

You can have the product turn off automatically if it is not used for a specified period of time.

1. Select the  home icon, if necessary.
2. Select **Settings > Basic Settings**.
3. Select **Power Off Timer**.
4. Select a time period between **30minutes** and **12h** (12 hours).
5. Select the  return home icon to return to the home screen.

**Parent topic:** [Using Power Saving Settings](#)

## Using the Epson Smart Panel Mobile App

Use this free Apple and Android app to scan with networked Epson products.

**Note:** Epson Smart Panel does not support scanning with a carrier sheet or scanning for originals that are 15.5 inches (393.8 mm) or longer.

1. Connect your product to your wireless network. See the link below.
2. Visit [epson.com/connect](http://epson.com/connect) (U.S.), [epson.ca/connect](http://epson.ca/connect) (Canada), or [latin.epson.com/connect](http://latin.epson.com/connect) (Latin America) to learn more about Epson Smart Panel and check the compatibility of your mobile device.
3. Download Epson Smart Panel from the Apple App Store or Google Play.
4. Connect your mobile device to the same wireless network as your product.
5. Open Epson Smart Panel and select your Epson product, if necessary.

Now you are ready to scan with your mobile device and your Epson product.

**Parent topic:** [Product Basics](#)

### Related tasks

[Setting Up Network Scanning](#)

[Starting a Scan from a Smartphone or Tablet](#)

---

# Loading Originals

Follow the instructions here to load your originals into the product.

[Loading Originals in the Input Tray](#)

[Loading Plastic and Laminated Cards in the Input Tray](#)

[Loading Special Originals](#)

## Loading Originals in the Input Tray

You can load originals that meet the document specifications in the input tray.

**Caution:** Do not load photos, or valuable original documents or artwork, directly into the input tray. This may wrinkle or damage the original. Load these originals using an optional carrier sheet.

**Note:** Photos scanned using a document scanner may not have the same color depth as the original. Use a flatbed photo scanner to achieve the best color reproduction of photos.

The steps below describe loading originals of the same size. To load originals of multiple sizes at once, see the link at the end of these steps.

1. Pull up the input tray extension.

2. Pull out the output tray and its extension, and open the stopper.

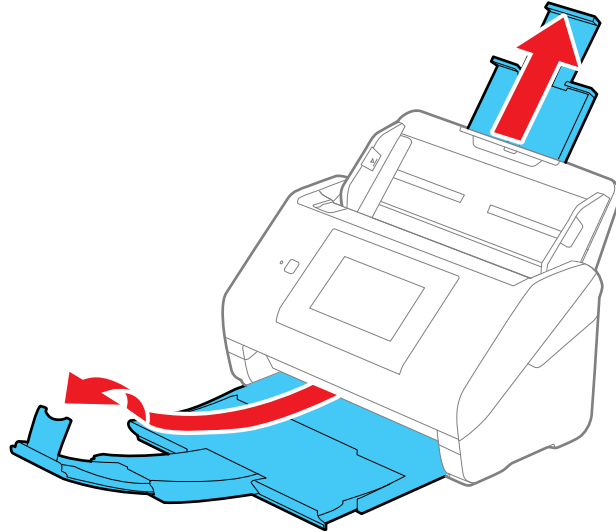

**Note:** If you are loading an original that is 15.5 inches (393.8 mm) or longer, do not pull out the input or output tray extensions and do not open the stopper.

3. Slide the input tray edge guides all the way out.

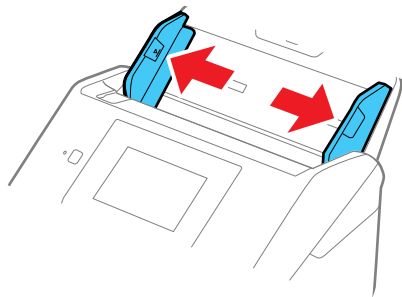

4. If you are loading a multi-page original, fan your stack of originals.

**Note:** If you are loading an original that is 15.5 inches (393.8 mm) or longer, load only one sheet at a time.

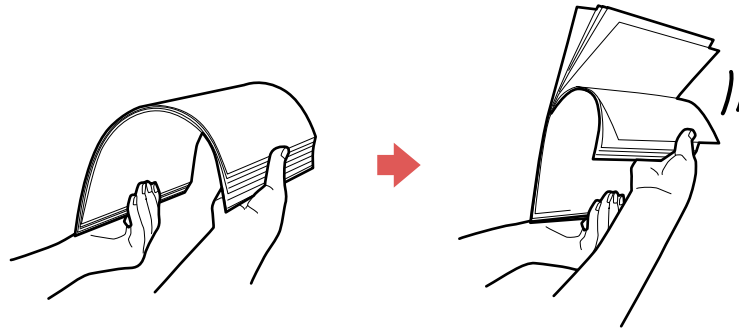

5. Stack the originals with the printed side facing down and slide the stack so the leading edge is at an angle as shown.

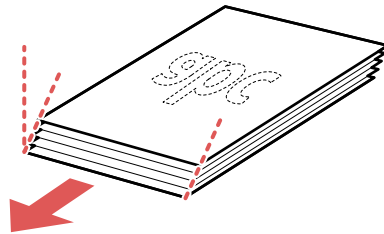

6. Do one of the following to load originals:

- Load standard originals into the input tray printed side down and top edge first, and guide them in until they meet resistance.

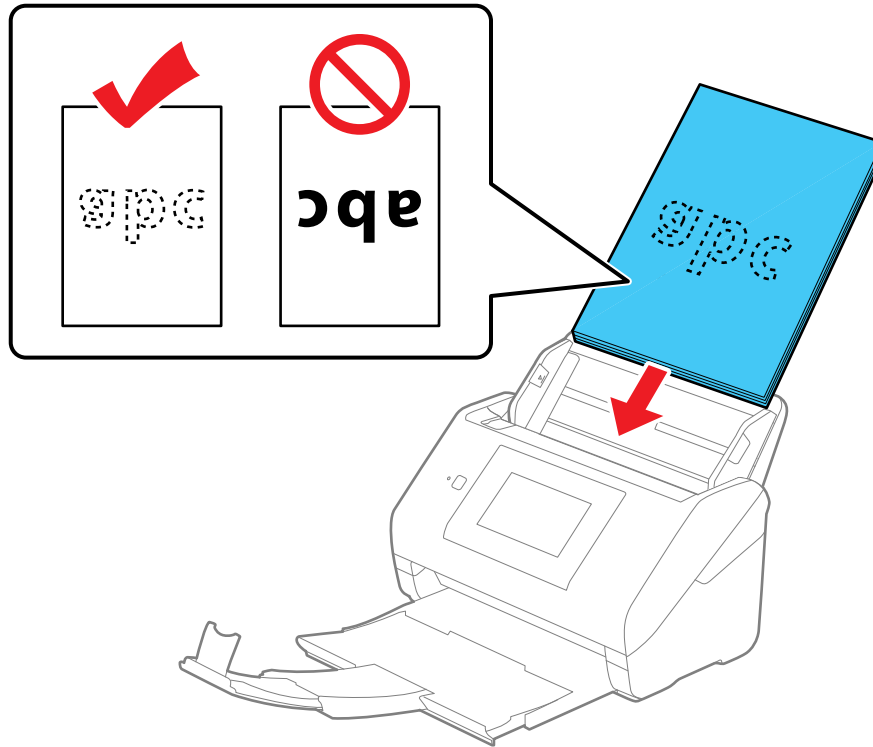

- If you are loading paper business cards, load up to 30 cards (printed side down and long edge first) into the input tray horizontally, and slide them in until they meet resistance.

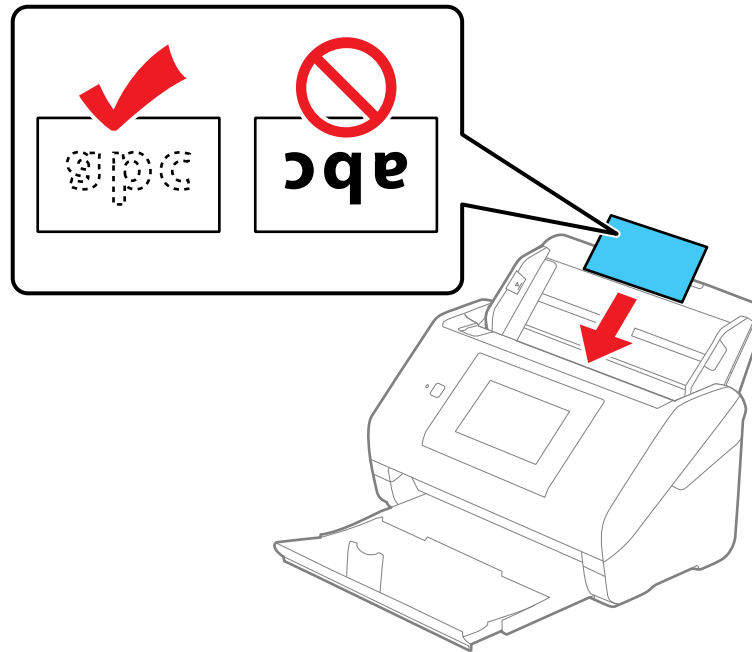

- If you are loading hole-punched originals, load them with the holes facing down or to the side as shown. The holes must be within 1.2 inches (30 mm) of the edge of the originals.

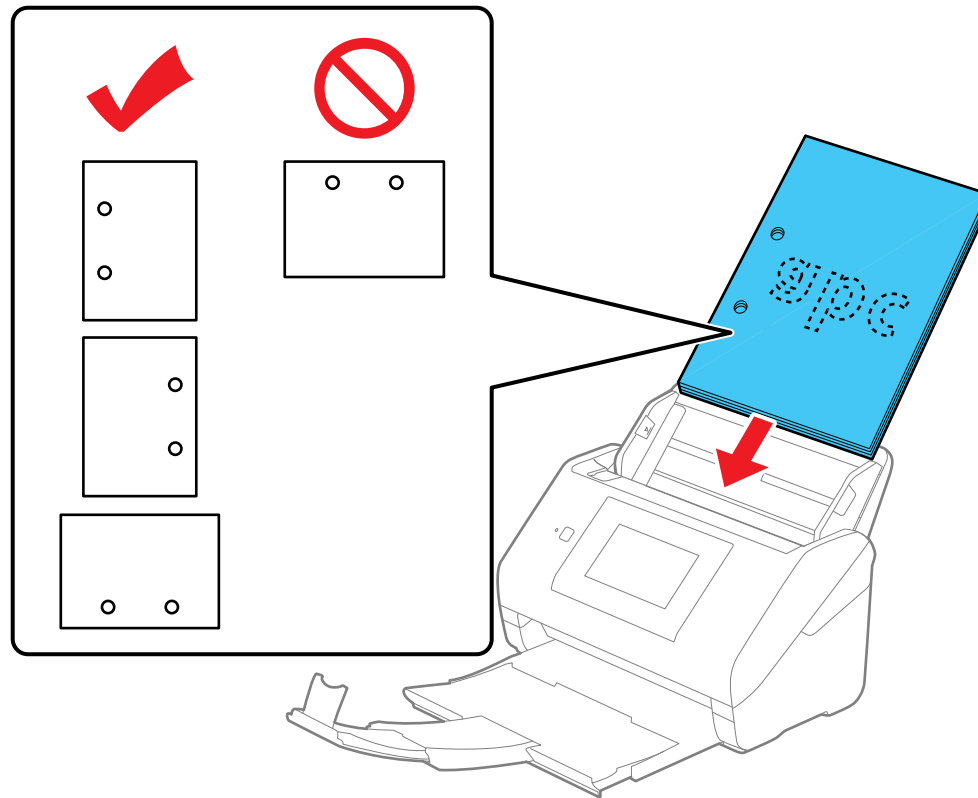

7. Slide the edge guides against the edges of the original.

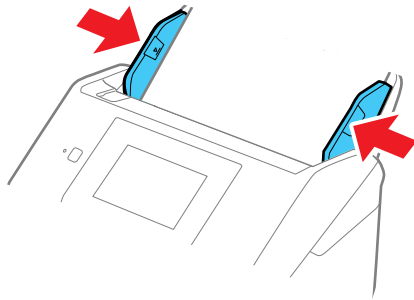

**Note:** If you are scanning originals that are 15.5 inches (393.8 mm) or longer, support the original as it enters into and ejects from the product as shown and use the following resolutions:

- 15.5 to 53 inches (393.8 to 1346.2 mm): 600 dpi or less
- 53 to 215 inches (1346.2 to 5461 mm): 300 dpi or less



- 215 to 240 inches (5461 to 6096 mm): 200 dpi or less

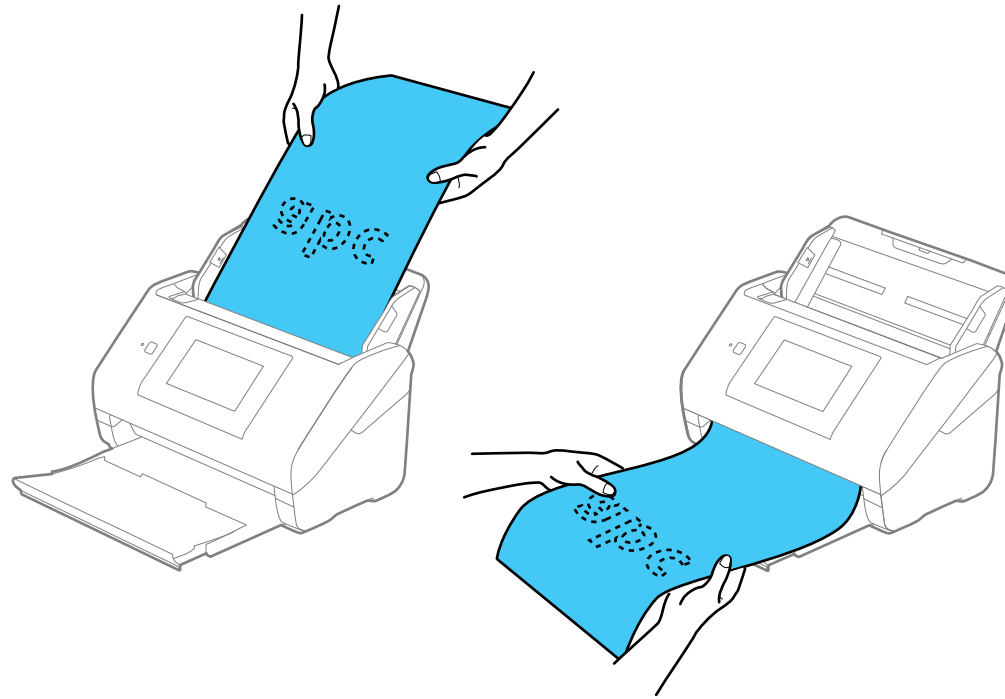

8. If necessary during scanning, adjust the position of the stopper on the output tray extension to fit the ejected originals.

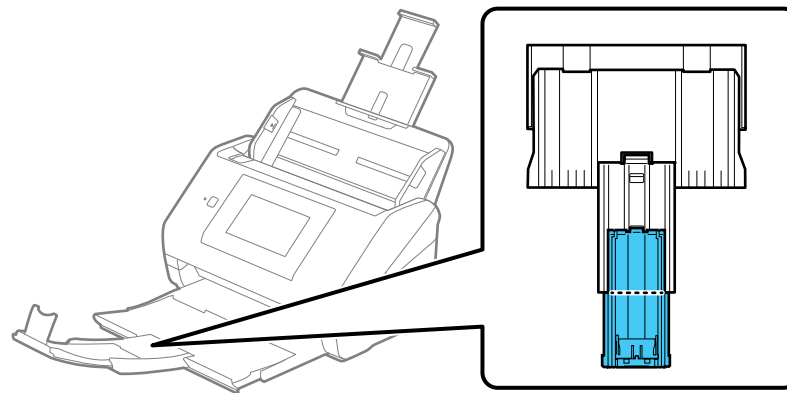

**Note:** If thicker paper does not eject properly or falls from the output tray, push in the output tray and allow the originals to eject freely onto the surface below the product. If the scanned images are affected by the originals ejecting below the product, try placing the product on the edge of a table where the ejected originals can drop freely.

If scanning thin or wrinkled paper causes frequent paper jams or double feeds, slow down the feeding speed by selecting **Settings > Scanner Settings > Slow > On** on the LCD screen.

If your scanned original contains staples, a paper feed error is detected and the Paper Protection feature stops the scanning process automatically to reduce damage to the original. Remove the original from the product, remove the staples, and try scanning again. If a paper jam still occurs, change the Paper Protection detection level by selecting **Settings > Scanner Settings > Paper Protection** on the LCD screen and selecting the desired level.

**Note:** The Paper Protection feature does not prevent all documents from being damaged. Paper feed errors may not be detected depending on the paper feeding conditions.

[Loading Multiple Sizes of Originals in the Input Tray](#)

[Original Document Specifications](#)

**Parent topic:** [Loading Originals](#)

**Related references**

[Original Document Specifications](#)

[Plastic and Laminated Card Specifications](#)

[Special Original Specifications](#)

[User Replaceable Epson Product Parts](#)

**Related topics**

[Scanning](#)

## Loading Multiple Sizes of Originals in the Input Tray

You can load originals of different sizes, paper types, and thicknesses at one time in the input tray. Just make sure they meet the original document specifications.

**Caution:** Do not load photos, or valuable original documents or artwork, directly into the input tray. This may wrinkle or damage the original. Load these originals using an optional carrier sheet.

**Note:** Photos scanned using a document scanner may not have the same color depth as the original. Use a flatbed photo scanner to achieve the best color reproduction of photos.

1. Pull up the input tray extension.
2. Pull out the output tray and its extension, and open the stopper.

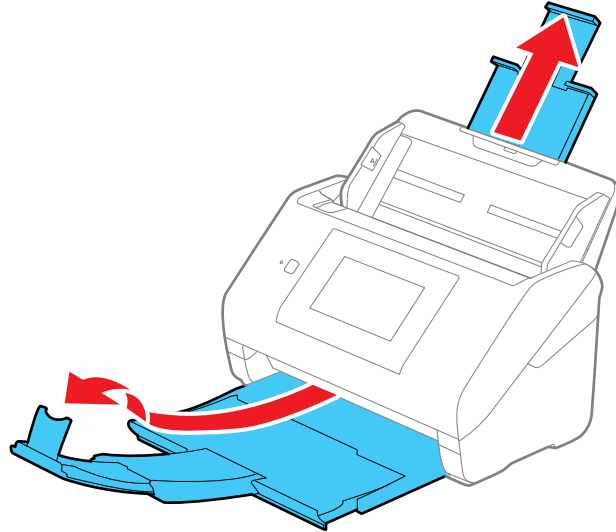

**Note:** If you are loading originals that are 15.5 inches (393.8 mm) or longer, do not pull out the input or output tray extensions and do not open the stopper.

3. Slide the input tray edge guides all the way out.

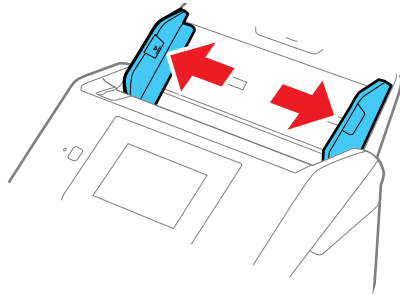

4. Load the originals in the center of the input tray in descending order of paper size with the widest at the back and the narrowest at the front. Slide them in until they meet resistance. Make sure the printed sides are facedown and the top edges are slightly angled in the input tray.

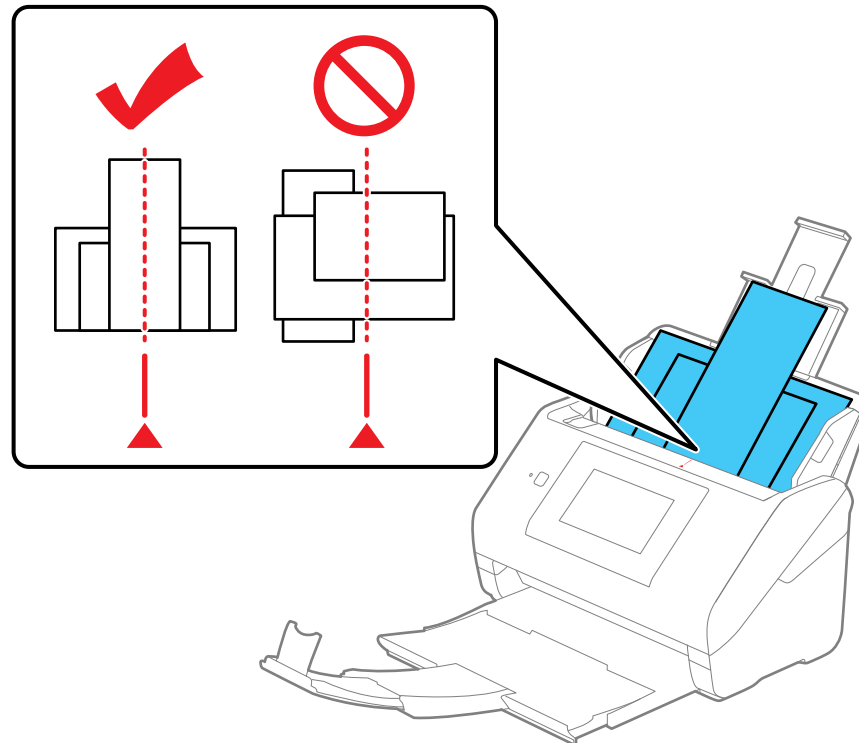

5. Slide the edge guides against the edges of the widest original.
6. If necessary during scanning, adjust the position of the stopper on the output tray extension to fit the ejected originals.

**Note:** If thicker paper does not eject properly or falls from the output tray, push in the output tray and allow the originals to eject freely onto the surface below the product. If the scanned images are affected by the originals ejecting below the product, try placing the product on the edge of a table where the ejected originals can drop freely.

If scanning thin or wrinkled paper causes frequent paper jams or double feeds, slow down the feeding speed by selecting **Settings > Scanner Settings > Slow > On** on the LCD screen.

If your scanned original contains staples, a paper feed error is detected and the Paper Protection feature stops the scanning process automatically to reduce damage to the original. Remove the original from the product, remove the staples, and try scanning again. If a paper jam still occurs, change the Paper Protection detection level by selecting **Settings > Scanner Settings > Paper Protection** on the LCD screen and selecting the desired level.

**Note:** The Paper Protection feature does not prevent all documents from being damaged. Paper feed errors may not be detected depending on the paper feeding conditions.

You can also scan originals of multiple sizes by loading them one by one using the **Automatic Feeding Mode** setting in Epson Scan 2.

**Parent topic:** [Loading Originals in the Input Tray](#)

**Related topics**

[Scanning](#)

## Original Document Specifications

You can load original documents that meet these specifications in your product.

Paper type	Paper size	Paper weight	Loading capacity
Plain paper Fine paper Recycled paper	Letter (8.5 × 11 inches [216 × 279 mm])	7 to 110 lb (27 to 413 g/m <sup>2</sup> )	21 lb (80 g/m <sup>2</sup> ): 100 sheets
	A4 (8.3 × 11.7 inches [210 × 297 mm])		24 lb (90 g/m <sup>2</sup> ): 86 sheets
	A5 (5.8 × 8.2 inches [148 × 210 mm])		28 lb (104 g/m <sup>2</sup> ): 74 sheets
	A6 (4.1 × 5.8 inches [105 × 148 mm])		34 lb (127 g/m <sup>2</sup> ): 62 sheets
	B5 (7.2 × 10.1 inches [182 × 257 mm])		42 lb (157 g/m <sup>2</sup> ): 50 sheets
	B6 (5 × 7.2 inches [128 × 182 mm])		56 lb (209 g/m <sup>2</sup> ): 38 sheets
	A8 (2.1 × 2.9 inches [52 × 74 mm])	34 to 110 lb (127 to 413 g/m <sup>2</sup> )	68 lb (256 g/m <sup>2</sup> ): 30 sheets
			110 lb (413 g/m <sup>2</sup> ): 18 sheets Loading capacity may vary depending on the paper type.
	Width: 2.0 to 8.5 inches (50.8 to 215.9 mm) Height: 15.5 to 240 inches (393.8 to 6096 mm)*	13 to 35 lb (50 to 130 g/m <sup>2</sup> )	1 sheet

Paper type	Paper size	Paper weight	Loading capacity
Plain paper Fine paper Recycled paper	Legal (8.5 × 14 inches [216 × 356 mm])	7 to 110 lb (27 to 413 g/m <sup>2</sup> )	21 lb (80 g/m <sup>2</sup> ): 80 sheets 24 lb (90 g/m <sup>2</sup> ): 69 sheets 28 lb (104 g/m <sup>2</sup> ): 59 sheets 34 lb (127 g/m <sup>2</sup> ): 50 sheets 42 lb (157 g/m <sup>2</sup> ): 40 sheets 56 lb (209 g/m <sup>2</sup> ): 30 sheets 68 lb (256 g/m <sup>2</sup> ): 24 sheets 110 lb (413 g/m <sup>2</sup> ): 14 sheets Loading capacity may vary depending on the paper type.
Paper business cards	Business cards	Up to 56 lb (210 g/m <sup>2</sup> )	30 cards loaded horizontally

\* Supported only when scanning from a computer; see table below for more information.

#### Specifications for Long Paper

Scanning Option	Resolution	Maximum Length
Scanning from a computer	50 to 200 dpi	240 inches (6096 mm)
Scanning from the control panel using the <b>Computer</b> option	201 to 300 dpi	215 inches (5461 mm)
	301 to 600 dpi	53 inches (1346 mm)

Scanning Option	Resolution	Maximum Length
Scanning from the control panel using the following options: <ul style="list-style-type: none"> <li>• <b>Network Folder/FTP</b></li> <li>• <b>Email</b></li> <li>• <b>Cloud</b></li> <li>• <b>USB Drive</b></li> <li>• <b>Scan to My Email</b></li> <li>• <b>Scan to My Folder</b></li> </ul>	200 dpi	36 inches (914 mm)
	300 dpi	
	600 dpi	Not supported
Scanning from the control panel using the <b>WSD</b> option	100 dpi 300 dpi	Not supported

**Note:** Epson Smart Panel does not support scanning for originals that are 15.5 inches (393.8 mm) or longer.

The following types of originals may not be successfully scanned or may require special attention:

- Originals with uneven surfaces, such as embossed documents or letterhead
- Originals with wrinkles or fold lines
- Perforated originals
- Originals with labels or stickers
- Carbonless paper
- Curled originals
- Coated paper

**Note:** Lightly wrinkled paper may scan better if you slow down the feeding speed during scanning or smooth out the wrinkles before loading. Use a carrier sheet to scan delicate originals or originals that are easily wrinkled. To scan originals that are incorrectly detected as double feeds, select **Settings > Scanner Settings > DFDS Function** on the LCD screen and set it to **On** to disable the **Detect Double Feed** setting for the next scan, or set the **Detect Double Feed** setting to **Off** on the Main Settings tab in the Epson Scan 2 window.



**Caution:** Do not load the following types of originals directly in the product, or they may be damaged or may damage the product:

- Photos
- Originals that are bound
- Passports
- Thermal paper
- Fabric or other non-paper originals
- Originals containing staples or paper clips
- Originals with wet ink or glue
- Ripped originals
- Heavily wrinkled or curled originals
- Originals with holes on the bottom of them
- Transparencies
- Originals with carbon paper backing
- Originals with sticky notes attached
- Glossy originals

**Note:** Photos scanned using a document scanner may not have the same color depth as the original. Use a flatbed photo scanner to achieve the best color reproduction of photos.

**Parent topic:** [Loading Originals in the Input Tray](#)

## **Loading Plastic and Laminated Cards in the Input Tray**

You can load plastic and laminated cards that meet the card specifications in the input tray.

1. Pull out the output tray and open the stopper. Do not pull out the extensions.

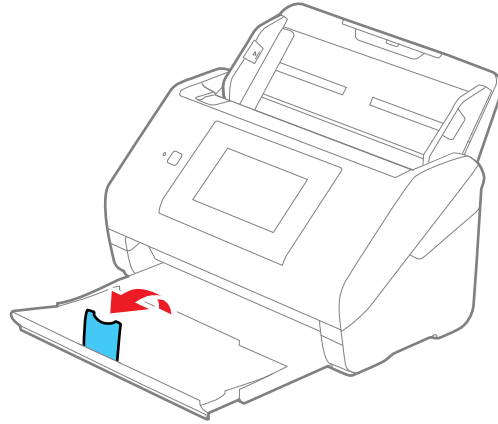

2. Slide the input tray edge guides all the way out.

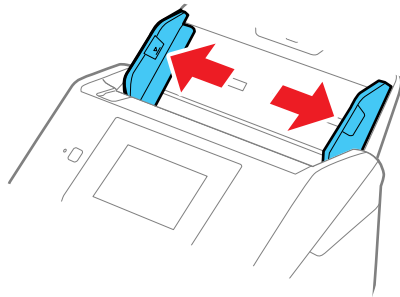

3. Load plastic or laminated cards (printed side down and long edge first) into the input tray horizontally, and slide them in until they meet resistance.

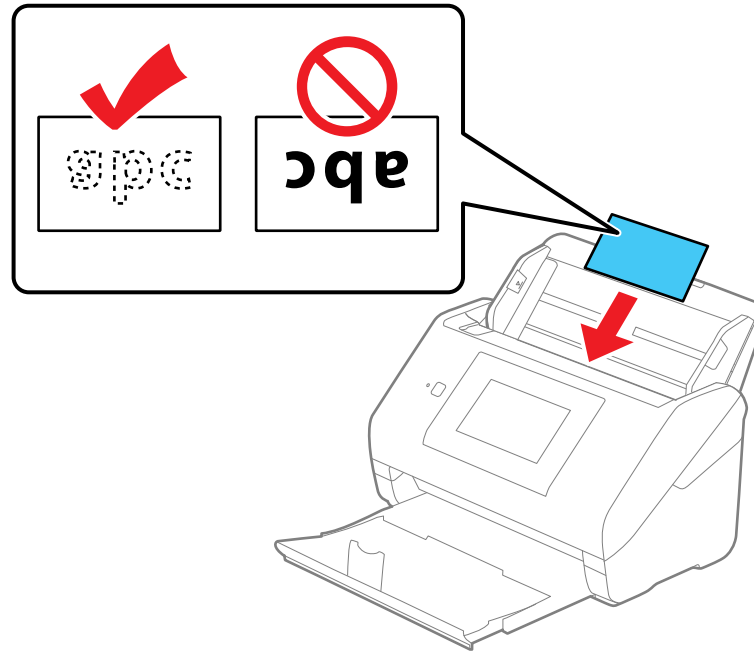

**Note:** Do not load plastic cards vertically.

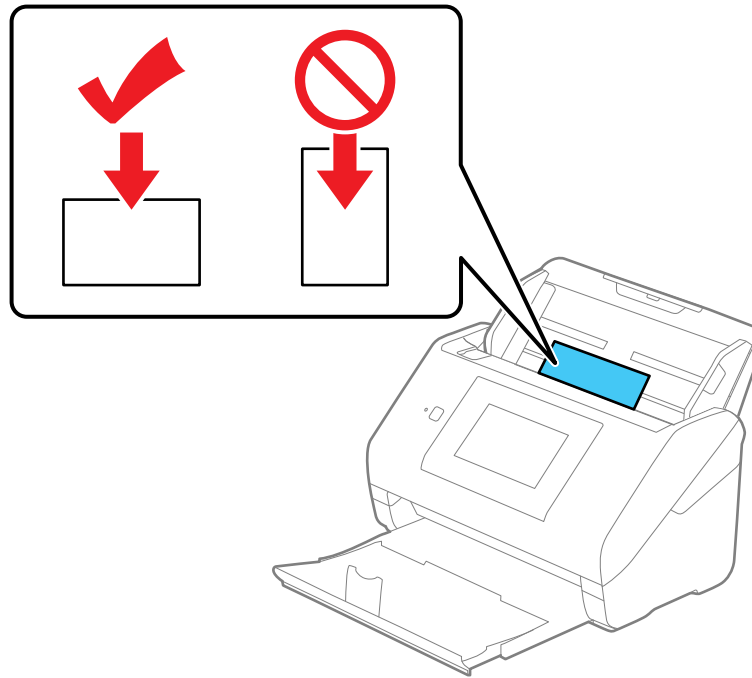

4. Slide the edge guides against the edges of the card.

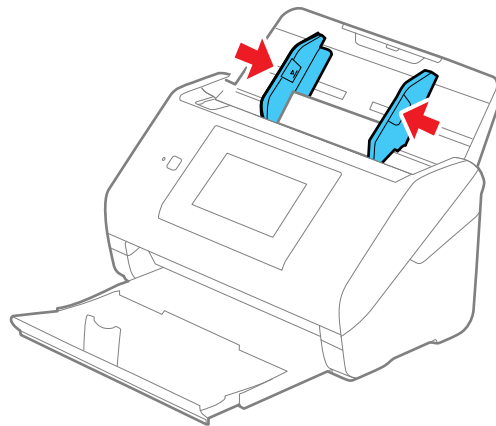

- Turn off the **Detect Double Feed** setting on the Main Settings tab in Epson Scan 2 when scanning the cards.

**Note:** If you do not disable the **Detect Double Feed** setting and a double feed error occurs, remove the plastic or laminated card from the input tray and reload it. Select **Settings > Scanner Settings > DFDS Function** on the LCD screen and set it to **On** to disable the **Detect Double Feed** setting for the next scan. The DFDS Function setting only disables the **Detect Double Feed** setting for one scan.

[Plastic and Laminated Card Specifications](#)

**Parent topic:** [Loading Originals](#)

**Related references**

[Plastic and Laminated Card Specifications](#)

**Related topics**

[Scanning](#)

## Plastic and Laminated Card Specifications

You can load original plastic and laminated cards that meet these specifications in your product.

**Note:** You cannot scan laminated cards using Epson Smart Panel.

Paper type	Paper size	Paper thickness	Loading capacity
Plastic cards, embossed (ISO7810 ID-1 compliant)	2.1 × 3.3 inches (54 × 85.6 mm)	0.05 inch (1.24 mm) maximum	1 card (horizontal)
Plastic cards, standard (ISO7810 ID-1 compliant)		0.03 inch (0.76 mm) to 0.04 inch (1.1 mm)*	5 cards (horizontal)
		smaller than 0.03 inch (0.76 mm)	
Laminated cards	4.7 × 5.9 inches (120 × 150 mm) or smaller	0.03 inch (0.8 mm) maximum	1 card

\* Resolution must be 300 dpi or less and **Slow** mode disabled

**Note:** Plastic cards with glossy surfaces may not scan properly.

**Parent topic:** [Loading Plastic and Laminated Cards in the Input Tray](#)

## Loading Special Originals

You can load photos or large, thick, or folded originals in the input tray using one or more carrier sheets. You can also load envelopes. Make sure the originals meet the specifications for special originals before loading them.

**Note:** Photos scanned using a document scanner may not have the same color depth as the original. Use a flatbed photo scanner to achieve the best color reproduction of photos.

1. Pull up the input tray extension.
2. Pull out the output tray and its extension, and open the stopper.

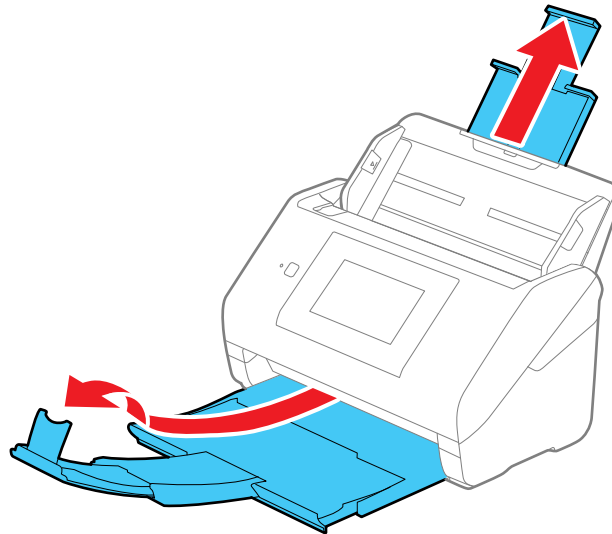

**Note:** If you are loading originals that are 15.5 inches (393.8 mm) or longer, do not pull out the input or output tray extensions and do not open the stopper.

3. Slide the input tray edge guides all the way out.

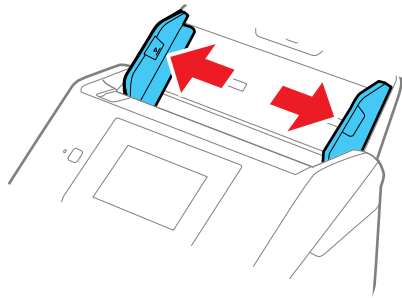

4. Load envelopes vertically in the input tray with the printed side down and the flap facing as shown. Slide in the envelopes until they meet resistance. Skip to step 7.

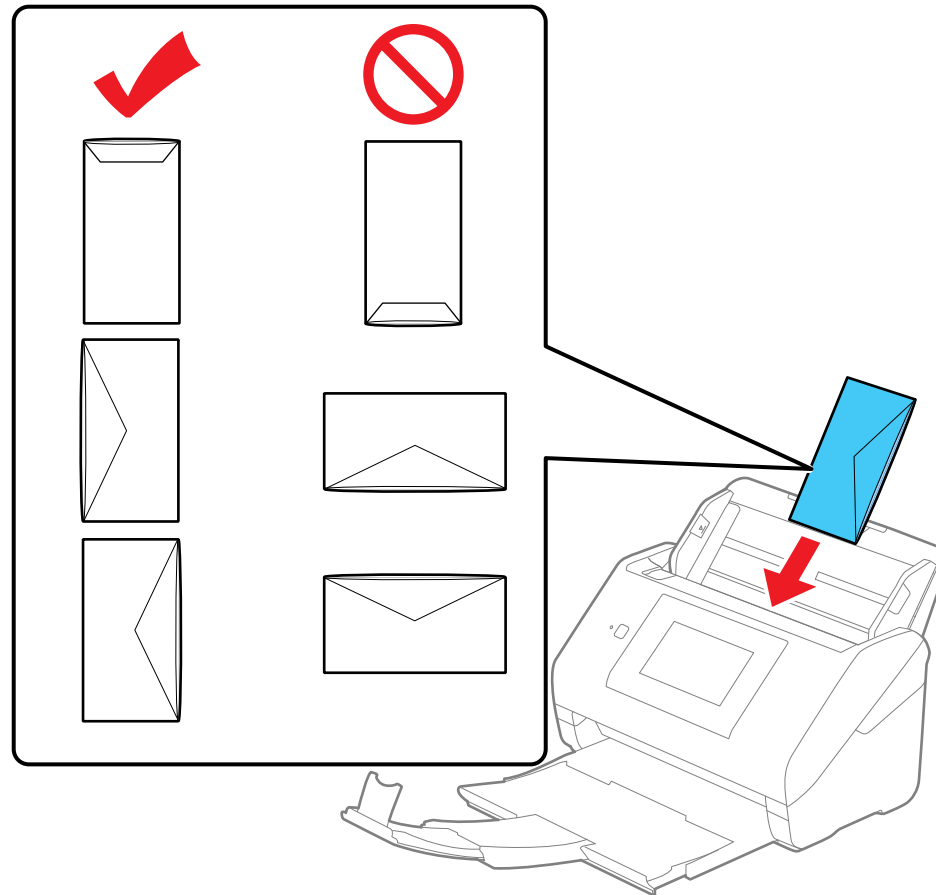

5. Do one of the following to load photos, or folded or irregularly shaped originals using a carrier sheet:

**Note:** Use only the carrier sheet designed for your product. The carrier sheet is automatically recognized by the product by the two small rectangular holes on the front edge, as shown. Keep the



holes clean and not covered. Do not load a carrier sheet that has scratches on it or one that has been scanned more than 3,000 times.

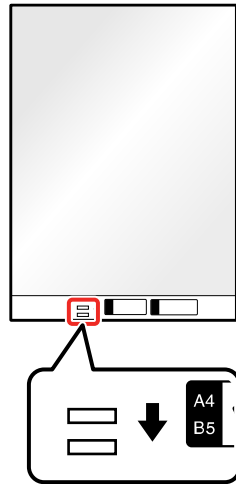

- For a Letter- or A4-size or larger original, fold it as shown and place it in the center of an optional carrier sheet. Make sure the illustration on the front edge of the carrier sheet is facing up.

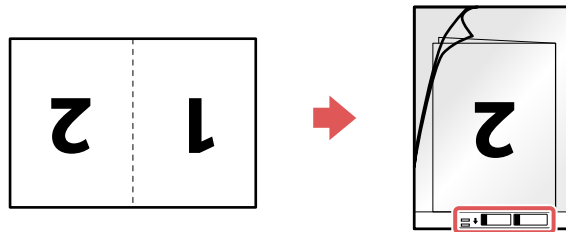

To scan both sides and stitch them together, set the appropriate setting in Epson Scan 2.

- For a photo or an irregularly shaped original, load it in the center of an optional carrier sheet with the printed side face down. Make sure the illustration on the front edge of the carrier sheet is facing up. If you are loading originals that are 11.7 inches (297 mm) or shorter, place the leading

edge of the original against the binding of the carrier sheet, as shown. Otherwise, the product may not detect the correct length of the original.

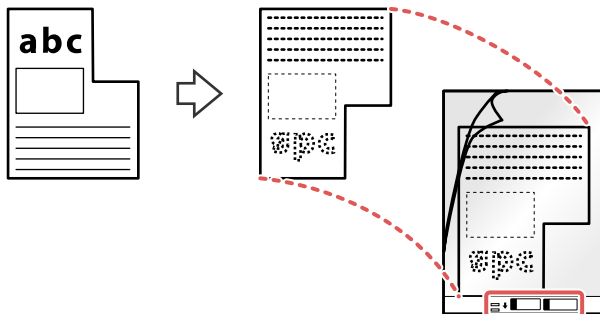

**Note:** Photos scanned using a document scanner may not have the same color depth as the original. Use a flatbed photo scanner to achieve the best color reproduction of photos.

6. Load the carrier sheet in the input tray as shown until it meets resistance.

**Folded original**

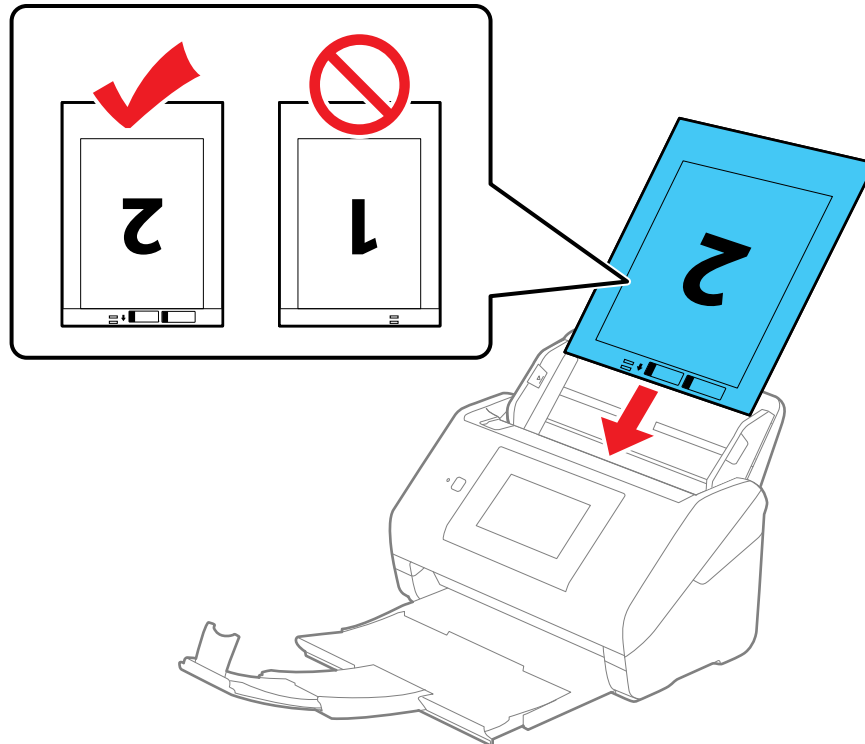

**Photo or irregularly shaped original**

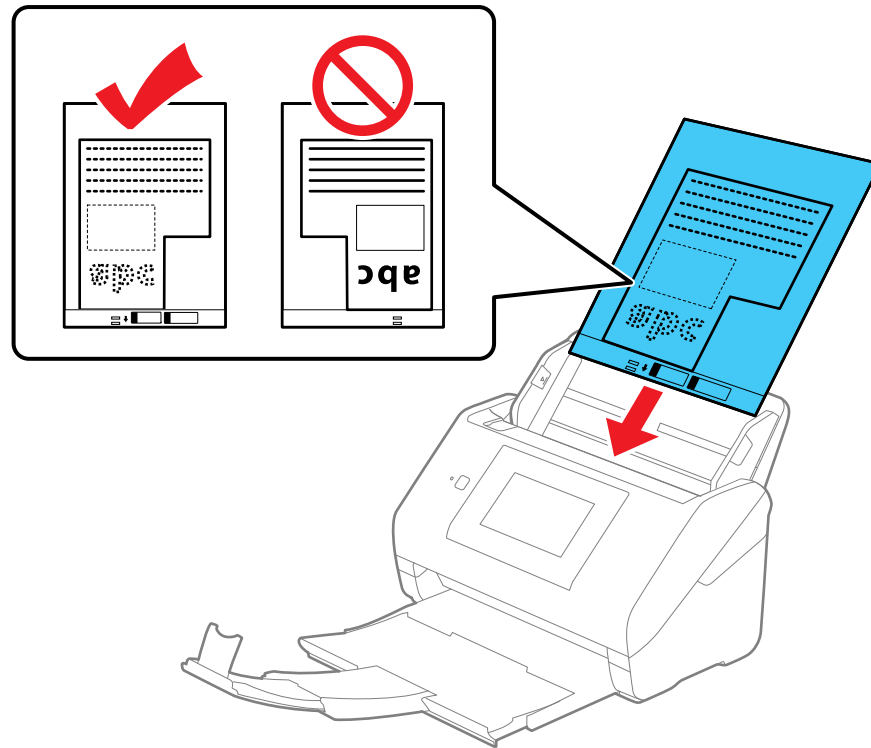

7. Slide the edge guides against the edges of the envelope or carrier sheet.

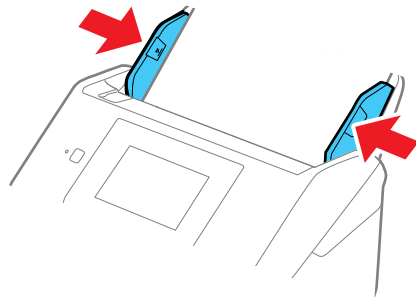

8. Turn off the **Detect Double Feed** setting on the Main Settings tab in Epson Scan 2 when scanning special originals.

**Note:** If the **Document Size** setting on the Main Settings tab in Epson Scan 2 is set to **Auto Detect**, **Paper Skew** is automatically selected as the **Correct Document Skew** setting.

9. If necessary during scanning, adjust the position of the stopper on the output tray extension to fit the ejected originals.

**Note:** If thicker paper does not eject properly or falls from the output tray, push in the output tray and allow the originals to eject freely onto the surface below the product. If the scanned images are affected by the originals ejecting below the product, try placing the product on the edge of a table where the ejected originals can drop freely.

[Special Original Specifications](#)

**Parent topic:** [Loading Originals](#)

**Related references**

[Special Original Specifications](#)

[User Replaceable Epson Product Parts](#)

**Related topics**

[Scanning](#)

## Special Original Specifications

You can load photos, envelopes, or large, thick, or folded originals that meet these specifications in your product.

**Note:** Photos scanned using a document scanner may not have the same color depth as the original. Use a flatbed photo scanner to achieve the best color reproduction of photos.

Paper type	Paper size	Paper thickness	Loading capacity
Large originals (plain paper, fine paper, or recycled paper) (load only in a carrier sheet)	Up to this size: A3 (11.7 × 16.5 inches [297 × 420 mm]) B4 (13.9 × 9.84 inches [353 × 250 mm]) Legal (8.5 × 14 inches [216 × 356 mm]); only load above sizes if folded in half Custom sizes up to 17 inches (431.8 mm) wide and 11.7 inches (297 mm) long; originals wider than 8.5 inches (215.9 mm) must be folded in half	0.012 inch (0.3 mm) maximum  (excluding the thickness of the carrier sheet)	10 carrier sheets
Photos (load only in a carrier sheet)	Up to this size: A4 (8.3 × 11.7 inches [210 × 297 mm])	0.012 inch (0.3 mm) maximum  (excluding the thickness of the carrier sheet)	10 carrier sheets
Envelopes	4.49 × 6.38 inches (114 × 162 mm) 4.33 × 8.66 inches (110 × 220 mm)	0.015 inch (0.38 mm) maximum	10 envelopes
Irregularly shaped originals (load only in a carrier sheet)	Up to this size: A4 (8.3 × 11.7 inches [210 × 297 mm])	0.012 inch (0.3 mm) maximum  (excluding the thickness of the carrier sheet)	10 carrier sheets

**Note:** Carrier sheets can only be used when scanning from a computer, or scanning from the product control panel using the **Computer** option. You cannot use a carrier sheet when scanning from the control panel using the following options: **Network Folder/FTP, Email, Cloud, USB Drive, WSD, Scan to My Email, or Scan to My Folder.**

**Parent topic:** [Loading Special Originals](#)

---

## Wi-Fi or Wired Networking

See these sections to use your scanner on a Wi-Fi or wired network.

[Network Security Recommendations](#)

[Connecting to an Existing Wi-Fi Network](#)

[Wi-Fi Direct \(Simple AP\) Mode Setup](#)

[Wi-Fi Protected Setup \(WPS\)](#)

[Setting Up Network Scanning](#)

[Configuring Email Server Settings](#)

[Setting Up a Shared Network Folder](#)

[Changing or Updating Network Connections](#)

[Disabling Wi-Fi Features](#)

## Network Security Recommendations

To help deter unauthorized access to your product over a network, you should protect your network environment using appropriate security measures.

Security measures such as these can help deter threats such as loss of user data, use of telephone and fax lines, and other intrusions:

- **Enable security on your wireless LAN**

Enable the appropriate security on the wireless LAN you plan to use with your product. Network security such as a network password can deter interception of traffic over the wireless LAN. Your router may already have a default password enabled by your Internet service provider (ISP). See your ISP and router documentation for instructions on how to change the default password and better secure your network.

- **Connect your product only to a network protected by a firewall**

Connecting your product directly to the Internet may leave it vulnerable to security threats. Instead, connect it to a router or other network connection protected by a firewall. Your router may already have a firewall set up by your Internet service provider; check with your ISP for confirmation. For best results, set up and use a private IP address for your network connection.

- **Change the default administrator password on your product**

If your product has an option to set an administrator password, change the default administrator password to deter access by unauthorized users to personal data stored on your product, such as IDs, passwords, and contact lists.

Parent topic: [Wi-Fi or Wired Networking](#)

## Connecting to an Existing Wi-Fi Network

You can set up your product to communicate with your computer using a wireless router or access point. The wireless router or access point can be connected to your computer over a wireless or wired network.

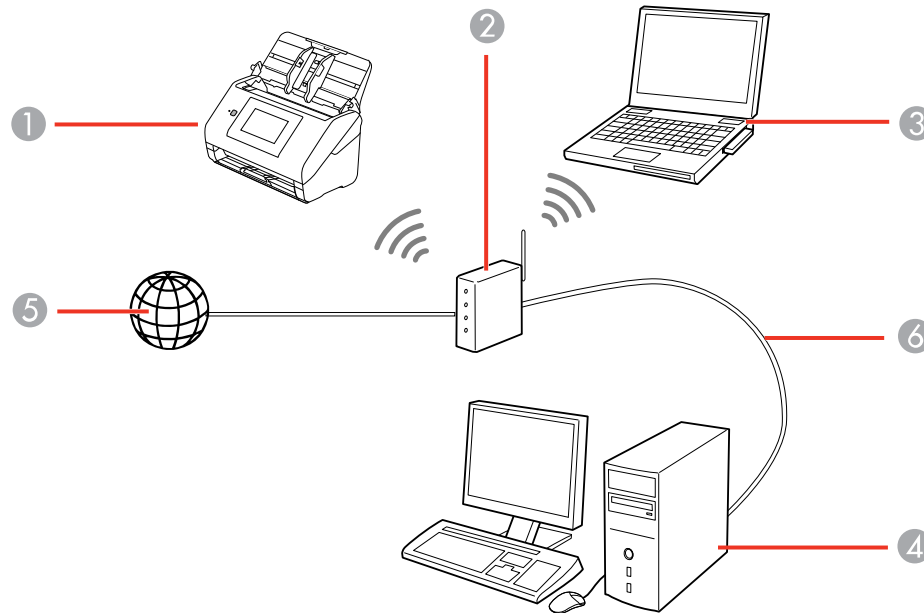

- 1 Epson product
- 2 Wireless router or access point
- 3 Computer with a wireless interface
- 4 Computer
- 5 Internet
- 6 Ethernet cable (used only for wired connection to the wireless router or access point)

[Selecting Wireless Network Settings from the Control Panel](#)



Parent topic: [Wi-Fi or Wired Networking](#)



## Selecting Wireless Network Settings from the Control Panel



You can select or change wireless network settings using your product control panel.

To install your product on a wireless network, follow the instructions on the *Start Here* sheet and install the necessary software by downloading it from the Epson website. The installer program guides you through network setup.

1. Select the  home icon, if necessary.
2. Press the  icon.
3. Select **Router**.
4. Select **Start Setup** or **Change Settings**.
5. Select **Wi-Fi Setup Wizard**.
6. Select the name of your wireless network or select **Enter Manually** to enter the name manually. Use the displayed keypad to enter your network name.
7. Select the **Password** field and enter your wireless password using the displayed keypad.



**Note:** The network name and password are case sensitive. Be sure to correctly enter uppercase and lowercase letters, and numeric or special characters.

- To move the cursor, press the left or right arrows.
- To change the case of letters, press .
- To delete the previous character, press .
- To enter numbers and symbols, press **123#**.

- To enter a space, press **Space**.
8. Select **OK** when you finish entering your password.
  9. Confirm the displayed network settings and select **Start Setup** to save them.
  10. Select the  return home icon to return to the home screen.

You see the  icon on the LCD screen and should be able to connect to your product directly from your computer or device, and then scan. If you are scanning from a computer, make sure you installed the network software.

**Note:** If you don't see the  icon, you may have selected the wrong network name or entered the password incorrectly. Repeat these steps to try again.

**Parent topic:** [Connecting to an Existing Wi-Fi Network](#)

**Related tasks**

[Setting Up Network Scanning](#)

**Related topics**

[Using the Control Panel](#)

## Wi-Fi Direct (Simple AP) Mode Setup

You can set up your product to communicate directly with your computer or another device without requiring a wireless router or access point. In Wi-Fi Direct (Simple AP) Mode, the product itself acts as a network access point for up to 8 devices.

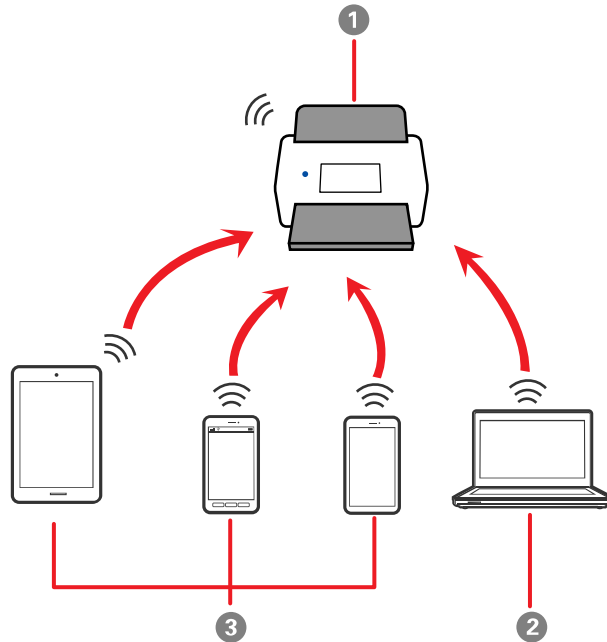

- 1 Epson product
- 2 Computer with a wireless interface
- 3 Other wireless devices

**Note:** Devices directly connected to the product cannot communicate with each other through the product.

[Connecting to a Mobile Device](#)

[Modifying the Wi-Fi Direct Network Name or Password](#)

[Setting Up Wireless Scanning from a Smart Device Using Epson Smart Panel](#)

**Parent topic:** [Wi-Fi or Wired Networking](#)



**Related tasks**

[Selecting Wireless Network Settings from the Control Panel](#)

## Connecting to a Mobile Device

You can connect a mobile device directly to the product without a wireless router or access point.



**Note:** Make sure the Epson Smart Panel app is installed on your mobile device before connecting to the product.

1. Select the  home icon, if necessary.
2. Press the  icon.
3. Select **Wi-Fi Direct**.
4. Select **Start Setup**.
5. Select your product in the Epson Smart Panel app to complete Wi-Fi Direct setup.
6. Select **Complete**.
7. Select the  return home icon to return to the home screen.

**Parent topic:** [Wi-Fi Direct \(Simple AP\) Mode Setup](#)

## Modifying the Wi-Fi Direct Network Name or Password

You can modify the Wi-Fi Direct name and password to create a more descriptive and secure Wi-Fi Direct network.



1. Select the  home icon, if necessary.
2. Press the  icon.
3. Select **Wi-Fi Direct**.
4. Select **Start Setup**.
5. Select **Change**.
6. Select one of the following:
  - To change the Wi-Fi Direct network name (SSID), select **Change Network Name** and select **Yes**. Select **Change**, then use the on-screen keyboard to enter the new network name.

**Note:** Your network name must be no more than 22 characters long.

- To change the Wi-Fi Direct password, select **Change Password** and select **Yes**. Use the on-screen keyboard to enter your new Wi-Fi Direct password.

**Note:** Your password must be at least 8 and no more than 22 characters long.

**Note:** If you have already connected devices or computers to your product via Wi-Fi Direct, they will be disconnected when you change the network name or password.

7. When entering your Wi-Fi Direct network name or password, do the following:
  - To move the cursor, press the left or right arrow.
  - To change the case of letters, select .
  - To delete the previous character, select .
  - To enter numbers and symbols, select **123#**.
  - To finish entering your network name or password, select **OK**.
8. Use your computer or wireless device to select the Wi-Fi network name (SSID) displayed on the LCD screen, then enter the password shown.

**Note:** Make a note of the SSID and password that appear.

9. Select the  return home icon to return to the home screen.  
Computers and wireless devices can now access your scanner using the new network name and password.

**Parent topic:** [Wi-Fi Direct \(Simple AP\) Mode Setup](#)

## Setting Up Wireless Scanning from a Smart Device Using Epson Smart Panel

You can use the Epson Smart Panel app to connect your Epson product to a wireless network or connect your smart device directly to the product. Epson Smart Panel is available on iOS and Android devices.

Make sure you have the following:

- A device that is connected to a wireless network
- The Epson Smart Panel app installed on the device
- The wireless network name (SSID) and password

1. Make sure the product is turned on and is ready to scan.

**Note:** You must perform initial setup before setting up wireless scanning.

2. Open the Epson Smart Panel app on your device.
3. Do one of the following:
  - If the app automatically recognizes the product, follow the on-screen instructions to set up the wireless connection.
  - If the app does not automatically recognize the product, select the **+** icon and continue with the next step.
4. On the next screen, select **Connect to a New Product**.
5. Select your product from the list.

**Note:** If your product is not listed, move closer to the product and try again. If the product is still not shown, connect your scanner to the wireless network again and then select **Connect to Existing Product** in the Epson Smart Panel app and follow the on-screen instructions. See the link below for wireless setup instructions.

6. Select **Next** to select the current wireless network.

**Note:** If you want to connect the product to a different wireless network, select **Change another Wi-Fi SSID**.

7. Enter the password for the wireless network and select **OK**.

The app starts configuring the product.

Your product is now connected to a wireless network and set up for use with the Epson Smart Panel app.

**Parent topic:** [Wi-Fi Direct \(Simple AP\) Mode Setup](#)

#### **Related tasks**

[Using the Epson Smart Panel Mobile App](#)

[Starting a Scan from a Smartphone or Tablet](#)

## Wi-Fi Protected Setup (WPS)

If your network uses a WPS-enabled wireless router or access point, you can quickly connect your product to the network using Wi-Fi Protected Setup (WPS).

**Note:** To check if your router or access point is WPS-enabled, look for a button labeled **WPS** on your router. If there is no hardware button, there may be a WPS setting in the software for the device. Check your network product documentation for details.



[Using WPS to Connect to a Network](#)

[Using WPS PIN Mode to Connect to a Network](#)

**Parent topic:** [Wi-Fi or Wired Networking](#)

## Using WPS to Connect to a Network

If you have a WPS-enabled wireless router or access point, you can use Wi-Fi Protected Setup (WPS) to connect your product to the network.

1. Select the  home icon, if necessary.
2. Press the  icon.
3. Select **Router**.
4. Select **Start Setup** or **Change Settings**.
5. Select **Push Button Setup (WPS)**.
6. Follow the instructions on the LCD screen to complete WPS setup.

**Note:** Make sure you press **Start Setup** within two minutes of activating WPS on your router.

7. Select the  return home icon to return to the home screen.

The  Wi-Fi icon displayed on the LCD screen indicates your wireless connection status. If the product is not connected to the network, repeat these steps to try again.



**Parent topic:** [Wi-Fi Protected Setup \(WPS\)](#)

### Related tasks

[Setting Up Network Scanning](#)

## Using WPS PIN Mode to Connect to a Network

If you have a WPS-enabled wireless router that supports PIN mode, you can use Wi-Fi Protected Setup (WPS) PIN mode to connect your product to the network.

1. Select the  home icon, if necessary.
2. Press the  icon.
3. Select **Router**.
4. Select **Start Setup** or **Change Settings**.
5. Select **Others**.
6. Select **PIN Code Setup(WPS)**.
7. Follow the instructions on the LCD screen to complete WPS setup.

**Note:** Make sure you press **Start Setup** within two minutes of activating WPS on your router.

8. Select the  return home icon to return to the home screen.

The  Wi-Fi icon displayed on the LCD screen indicates your wireless connection status. If the product is not connected to the network, repeat these steps to try again.

**Parent topic:** [Wi-Fi Protected Setup \(WPS\)](#)

### Related tasks



[Setting Up Network Scanning](#)

## Setting Up Network Scanning

You can set up network scanning to your product through a direct connection to your product.

First, manually configure your product to connect to your network. Then follow the instructions here to set up your computer for network scanning using the Epson Scan 2 Utility. Your product must be turned on and connected to the network.

**Note:** Make a note of the IP address or host name of the product so you can enter it in these steps.

1. Do one of the following to start the Epson Scan 2 Utility:
  - **Windows 11:** Click , then search for **Epson Scan 2 Utility** and select it.
  - **Windows 10:** Click  > **EPSON** > **Epson Scan 2 Utility**.



- **Windows 8.x:** Navigate to the **Apps** screen and select **Epson Scan 2 Utility**.
  - **Windows 7:** Click  > **All Programs** > **EPSON** > **Epson Scan 2** > **Epson Scan 2 Utility**.
  - **Mac:** Open the **Applications** folder, click **Epson Software**, and click **Epson Scan 2 Utility**.
2. Select **Settings** from the Scanner drop-down list.

You see a screen like this:

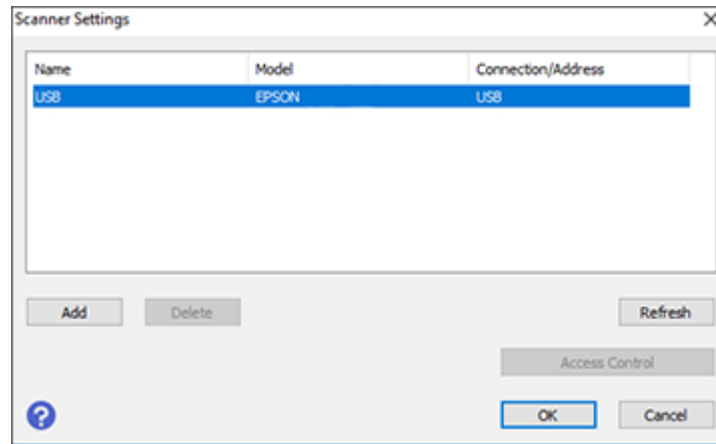

**Note:** If you see an **Enable Editing** button (Windows) or the lock icon (Mac), click it so that you can modify the product settings.

3. Select your product and click **Add**.

You see a screen like this:

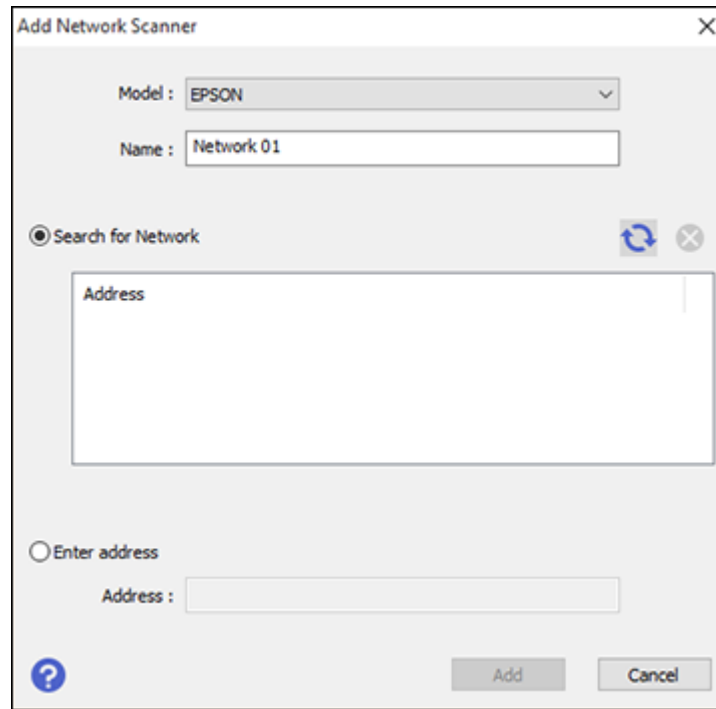

4. Do one of the following:
  - Under **Search for Network**, select the IP address of your Epson product and click **Add**.
  - Select the **Enter address** setting, type in the IP address or host name of your Epson product, and click **Add**.
5. Click **OK** to check the connection.  
You see a confirmation message.
6. Click **OK** to save your settings and close the Epson Scan 2 Utility.

[Determining the Product's IP Address](#)



**Parent topic:** [Wi-Fi or Wired Networking](#)

#### **Related tasks**

[Selecting Wireless Network Settings from the Control Panel](#)

## Determining the Product's IP Address

If you have multiple products on your network, you need to know the IP address of the product when setting up network scanning.

1. Do one of the following to start EpsonNet Config:
  - **Windows 11:** Click , then search for **EpsonNet Config** and select it.
  - **Windows 10:** Click  > **EpsonNet** > **EpsonNet Config**.
  - **Windows 8.x:** Navigate to the **Apps** screen and select **EpsonNet Config**.
  - **Windows 7:** Click , and select **All Programs**. Select **EpsonNet** > **EpsonNet Config** > **EpsonNet Config**.
  - **Mac:** Open the **Applications** folder and select **Epson Software** > **EpsonNet** > **EpsonNet Config** > **EpsonNet Config**.
2. Locate your product in the list and write down the IP address.

Parent topic: [Setting Up Network Scanning](#)

## Configuring Email Server Settings

If you want to send a scanned file by email, you need to configure the email server. You can select settings for the email server using the control panel on the product.

**Note:** See the online [Administrator's Guide](#) for more information.

1. Select the  home icon, if necessary.
2. Select **Settings**.
3. Select **Network Settings**.
4. Select **Advanced**.
5. Select **Email Server**.
6. Select **Server Settings**.

You see a screen like this:



7. Select one of the options shown above, then select the settings you want to use. Contact your internet service provider if necessary to confirm the authentication method for the email server.
8. Select **Proceed** to save your settings.
9. Select **Close** to exit.
10. Select **Connection Check** to verify the connection to the email server.

[Email Server Settings](#)

**Parent topic:** [Wi-Fi or Wired Networking](#)

**Related tasks**

[Scanning to an Email](#)

## Email Server Settings

Setting name	Available options	Description
<b>Authentication Method</b>	<b>Off</b> <b>SMTP AUTH</b> <b>POP before SMTP</b>	Selects the authentication method for the scanner to access the mail server.  <b>SMTP AUTH:</b> Authenticates on the SMTP server (outgoing mail server) when sending the email. The mail server needs to support SMTP authentication.  <b>POP before SMTP</b> Authenticates on the POP3 server (receiving mail server) before sending the email. When you select this item, set the POP3 server.
<b>Authenticated Account</b>	—	Lets you enter a user name or email address for the mail server. Used with the <b>POP before SMTP</b> and <b>SMTP AUTH</b> methods.
<b>Authenticated Password</b>	—	Lets you enter a password for the authenticated account. Used with the <b>POP before SMTP</b> and <b>SMTP AUTH</b> methods.
<b>Sender's Email Address</b>	—	Lets you enter the email address to be displayed to the sender
<b>SMTP Server Address</b>	—	Lets you enter the address of the SMTP server
<b>SMTP Server Port Number</b>	—	Lets you enter the port number of the SMTP server. The default port is 25.
<b>Secure Connection</b>	<b>None</b> <b>STARTTLS</b> <b>SSL/TLS</b>	Selects the encryption protocol used by the email server. Used with the <b>SMTP AUTH</b> or <b>Off</b> authentication methods.
<b>Certificate Validation</b>	<b>Enable</b> <b>Disable</b>	Determines whether the CA Certificate is validated. You must import a CA certificate to use this setting.
<b>POP3 Server Address</b>	—	Lets you enter the address of the POP3 server using IPv4 or FQDN format.
<b>POP3 Server Port Number</b>	—	Lets you enter the port number of the POP3 server. The default port is 25.

**Parent topic:** [Configuring Email Server Settings](#)

## Setting Up a Shared Network Folder

Before you can scan to a network folder on your computer or on an FTP server, you need to create a shared folder and optionally register its location to your product's Contacts list. Select the links below as necessary to create and register the folder.

[Creating a Shared Network Folder](#)

[Registering Contacts for Email, Network, or FTP Scanning - Control Panel](#)

[Registering Contacts for Email, Network, or FTP Scanning - Web Config](#)

**Parent topic:** [Wi-Fi or Wired Networking](#)

## Creating a Shared Network Folder

You can create a shared network folder on your computer or an FTP site and register its location to your product's Contacts list.

**Note:** If you are creating a shared network folder on a Mac, see your Mac documentation for instructions on creating the folder. The instructions here are for Windows.

First make sure you connected your product and computer to the same network.

**Note:** If you are running a Home version of the Windows operating system, you cannot create a shared folder on your Windows desktop or in the Documents or Pictures folder unless you have created a Home Group Configuration for sharing. You can, however, create a shared folder in the root of the C: drive on your system.

If you want to scan to a folder on an FTP server, contact the FTP server administrator for the server address and authentication access to a shared folder on the server.

1. If you are scanning to a network folder on your computer, do one of the following to check the format of your computer name:
  - **Windows 11, Windows 10, or Windows 8.x:** Hold down the Windows key on your keyboard and press the **X** key. Select **System** from the list that appears. Check the Computer Name or Device Name listed for your computer on the System window.

- **Windows 7:** Click , right-click **Computer**, and select **Properties**. Check the Computer Name listed for your computer on the System window.

**Note:** The settings in these steps may vary, depending on your version of Windows. See Windows Help for details on your operating system.

2. If the computer's name uses any characters that are not alphanumeric (letters or numbers), do one of the following to change the computer's name:
  - **Windows 11, Windows 10, or Windows 8.x:** Select **Rename this PC** and follow the on-screen prompts.
  - **Windows 7:** Select **Change Settings**, change the computer's name, and click **OK**. (See Windows Help for instructions, if necessary.)

**Note:** You need to be logged into Windows as an administrator to change the computer's name. After changing the name, restart your computer.

3. Start File Explorer or Windows Explorer.
4. Create a folder on the Windows desktop with a folder name of 12 characters or less; otherwise, your product may not be able to access the folder.

**Note:** You need to be logged into Windows as an administrator to access the desktop folder and the document folder under each User folder.

5. Right-click the folder you created and select **Properties**.
6. On the **General** tab, deselect the **Read-only** checkbox to allow users to access the folder over the network.
7. Select the **Sharing** tab and click the **Advanced Sharing** button.

**Note:** You need to be logged into Windows as an administrator to select the **Advanced Sharing** button.

8. On the Advanced Sharing screen, select the **Share this folder** checkbox.
9. Click the **Permissions** button and select the following on the Share Permissions tab:
  - Select **Everyone** under Group or user names.
  - Select the checkbox in the **Allow** column for the **Change** setting.

10. Click **OK** to save the settings, then click **OK** again to close the Advanced Sharing window.
11. Select the **Security** tab and check that the Group or user names list at the top includes the current computer user and the administrators who can now access the folder.
12. Select the **Sharing** tab again and write down the **Network Path** listed under Network File and Folder Sharing at the top. This is the path you will register to your product's Contacts list so you can select it for network scanning.
13. Click **OK** or **Close**.

Now you can register the folder path to your product's Contacts list.

**Parent topic:** [Setting Up a Shared Network Folder](#)

#### **Related tasks**

[Entering Characters on the LCD Screen](#)

[Registering Contacts for Email, Network, or FTP Scanning - Control Panel](#)

[Registering Contacts for Email, Network, or FTP Scanning - Web Config](#)

[Scanning to a Network Folder or FTP Server](#)

## **Registering Contacts for Email, Network, or FTP Scanning - Control Panel**

You can register a list of contacts for scanning to email or to a network folder or FTP server.

1. Select the  home icon, if necessary.
2. Select **Settings**.
3. Select **Contacts Manager**. Enter the administrator password, if necessary.
4. Select **Register/Delete**.
5. Select **Add Entry**.
6. Select **Add Contact**.
7. Do one of the following:
  - To create a contact for scanning to email, select **Email**.
  - To create a location for scanning to a network folder or FTP, select **Network Folder/FTP**.
8. Select the **Registry Number** you want to use for the contact you are adding.
9. Select the **Name** field, use the displayed keyboard to enter the contact name (up to 30 characters), and select **OK**.
10. Select the **Index Word** field, use the displayed keyboard to enter a word to use when searching for an entry (up to 30 characters), and select **OK**. (This field is optional.)



11. Do the following as necessary for your contact:

- If you want to identify the contact as a frequently used address, select the **Assign to Frequent Use** field and select **On**. This makes it quicker to select the contact when you scan.
- For an email contact, select the **Email Address (Required)** field, use the displayed keyboard to enter the address, and press **OK**.
- For a network folder or FTP location, select the **Communication Mode** field and select **Network Folder (SMB)** or **FTP**. Then select the **Location (Required)** field, use the displayed keyboard to enter the network path to the shared folder, and select **OK**.

Enter the folder path name for the **Location** setting in one of the following formats depending on the **Communication Mode** setting you selected:

- **Network Folder (SMB)**: \\host name\folder name
- **FTP**: ftp://host name/folder name
- **FTPS**: ftps://host name/folder name
- **WebDAV (HTTPS)**: https://host name/folder name
- **WebDAV (HTTP)**: http://host name/folder name
- For a network folder or FTP location with a password, select the **User Name** field and use the displayed keyboard to enter the user name. Then select the **Password** field and enter the password.
- For an FTP location, enter the FTP server port number in the **Port Number** field. If there is a firewall between the product and FTP server, select the **Connection Mode** field and select **Passive Mode**.

12. Select **OK**.

**Parent topic:** [Setting Up a Shared Network Folder](#)

**Related tasks**

[Registering Contacts for Email, Network, or FTP Scanning - Web Config](#)

## Registering Contacts for Email, Network, or FTP Scanning - Web Config

You can register a list of contacts for scanning to email or to a network folder or FTP server using Web Config and your computer's internet browser.

Before you begin, make a note of the IP address or host name of the scanner so you can enter it in these steps.

**Note:** These instructions use Internet Explorer as an example browser.

1. Start Internet Explorer on a computer that is using the same network as your product.
2. Type your product's IP address into the address bar and press **Enter**.
3. Click **More Information**.
4. Click **Go on to the webpage (not recommended)**.
5. In the upper right corner of the screen, click **Log in** and enter the Administrator password.
6. Click on the **Scan** tab, then click **Contacts**.
7. Select the number you want to use for the contact you are adding and click **Edit**.
8. Do one of the following:
  - To create a contact for scanning to email, select **Email** as the **Type** setting.
  - To create a location for scanning to a network folder or FTP, select **Network Folder (SMB)** or **FTP** as the **Type** setting.
9. Enter the following information as necessary for your contact:
  - **Name**: The name to display in your product's contact list.
  - **Index Word**: Enter a word to identify this entry when searching for it (up to 30 characters). This field is optional.
  - **Assign to Frequent Use**: If you want to identify the contact as a frequently used address, select **On**. This makes it quicker to select the contact when you scan.
  - **Email Address**: For an email contact, the contact's email address.
  - **Save to**: For a network folder or FTP location, the network path to the shared folder.  
Enter the folder path name in one of the following formats depending on the **Type** setting you selected:
    - **Network Folder (SMB)**: \\host name\folder name
    - **FTP**: ftp://host name/folder name
    - **FTPS**: ftps://host name/folder name
    - **WebDAV (HTTPS)**: https://host name/folder name
    - **WebDAV (HTTP)**: http://host name/folder name
  - **User Name** and **Password**: Enter only if you have set up a password on your computer.
  - **Connection Mode**: For FTP locations, select **Passive Mode** if there is a firewall between the product and FTP server.
  - **Port Number**: For FTP locations, enter the port number.

- **Proxy Server Settings:** Select whether or not to use a proxy server.

10. Click **Apply**.

After a moment, you see a message telling you that contact registration is complete.

11. Close your web browser.

**Parent topic:** [Setting Up a Shared Network Folder](#)

#### **Related tasks**

[Registering Contacts for Email, Network, or FTP Scanning - Control Panel](#)

[Determining the Product's IP Address](#)

## **Changing or Updating Network Connections**

See these sections to change or update how your product connects to a network.

[Accessing the Web Config Utility](#)

[Changing a USB Connection to a Wi-Fi Connection](#)

[Changing a Wi-Fi Connection to a Wired Network Connection](#)

[Connecting to a New Wi-Fi Router](#)

**Parent topic:** [Wi-Fi or Wired Networking](#)

## **Accessing the Web Config Utility**

You can select your product's network settings and confirm its operating status using a web browser. You do this by accessing your product's built-in Web Config utility from a computer or other device that is connected to the same network as your product.

**Note:** You can also access the Web Config utility from the product information area in the Epson Smart Panel app.

**Note:** For more information on administration settings, see the online [Administrator's Guide](#).

1. Check your product's network status on the LCD screen (**Settings > Network Settings > Network Status**).
2. Note your product's IP address.
3. On a computer or other device connected to the same network as your product, open a web browser.
4. Enter your product's IP address into the address bar.

You see the available Web Config utility options.

**Parent topic:** [Changing or Updating Network Connections](#)

**Related tasks**

[Determining the Product's IP Address](#)

## Changing a USB Connection to a Wi-Fi Connection

If you have already connected your product to your computer using a USB connection, you can change to a Wi-Fi connection.

1. Disconnect the USB cable from your product.
2. Uninstall your product software.
3. Download and install your product software from the Epson website.

**Parent topic:** [Changing or Updating Network Connections](#)

## Changing a Wi-Fi Connection to a Wired Network Connection

If you have already connected your product to your computer wirelessly, you can change to a wired network connection if necessary.

1. Disable your product's Wi-Fi features.
2. Connect one end of an Ethernet network cable to the product's **LAN** port.
3. Connect the other end to any available LAN port on your router or access point.
4. Uninstall your product software.
5. Download and install your product software from the Epson website.
6. Follow the on-screen instructions to install the software.
7. When you see the Select Your Connection screen, select **Wired network connection**.
8. If you see a Select Setup Option screen, select **Set up printer for the first time**.
9. Continue following the rest of the on-screen instructions.

**Parent topic:** [Changing or Updating Network Connections](#)

**Related tasks**

[Disabling Wi-Fi Features](#)

## Connecting to a New Wi-Fi Router

If you change the wireless router you have been using on your network, you need to update your product's Wi-Fi connection to the new router.

**Note:** If your router uses a single network name (SSID) for both the 2.4 GHz and 5 GHz band, give each band its own network name (SSID) instead, such as Home Network 2.4 GHz and Home Network 5 GHz. See your router documentation for instructions.

1. Do one of the following:
  - **Windows:** Uninstall your product software.
  - **Mac:** Go to the next step.
2. Download and install your product software from the Epson website.



**Parent topic:** [Changing or Updating Network Connections](#)

### Related tasks

[Uninstalling Product Software - Windows](#)

## Disabling Wi-Fi Features

You may need to disable your product's Wi-Fi features if you change your network connection type or need to solve a problem with your network connection.

1. Select the  home icon, if necessary.
2. Press the  icon.
3. Select **Router**.
4. Select **Change Settings**.
5. Select **Others**.
6. Select **Disable Wi-Fi**.
7. Select **Start Setup** to disable Wi-Fi.
8. When finished, select the  return home icon to return to the home screen.

**Parent topic:** [Wi-Fi or Wired Networking](#)

---

# Scanning

You can scan your originals and save them as digital files.

[Starting a Scan](#)

## Starting a Scan

After placing your originals on your product for scanning, start scanning using one of these methods.

**Note:** You can also scan using Document Capture Pro (Windows) or Document Capture (Mac).

[Starting a Scan Using the Product Control Panel](#)

[Starting a Scan Using the Epson Scan 2 Icon](#)

[Starting a Scan from a Scanning Program](#)

[Starting a Scan from a Smartphone or Tablet](#)

[Scanning with Document Capture Pro or Document Capture](#)

[Scanning in Epson Scan 2](#)

[Scan Resolution Guidelines](#)

[Scanning Special Projects](#)

[Scanning with AirPrint](#)

[Authentication Scanning](#)

**Parent topic:** [Scanning](#)

## Starting a Scan Using the Product Control Panel

You can scan an image to a variety of destinations using your product's control panel.

1. Make sure you installed the product software and connected the product to your computer or network.

**Note:** Restart your computer after installing the product software to enable scanning from the control panel.

2. Place your original on the product for scanning.
3. Select the  home icon, if necessary.

4. Select one of the following options from the home screen:
  - **Computer** lets you scan to a connected computer using your saved scan settings.
  - **Network Folder/FTP** saves your scanned file to a pre-defined folder on a network computer or FTP server. To use this feature, you must first create a shared network folder or obtain the FTP site address, and optionally register the location to your product's contact list.
  - **Email** lets you send scanned files through a pre-defined email server.
  - **Cloud** sends your scanned files to a destination that you have registered with Epson Connect.
  - **USB Drive** lets you save the scanned file directly to a USB device connected to the product.
  - **WSD** lets you manage network scanning in Windows 11, Windows 10, Windows 8.x, or Windows 7. To use this feature on Windows 7, you must first set up a WSD (Web Services for Devices) port on your computer (the port is set up automatically on Windows 11, Windows 10, and Windows 8.x).
5. Follow the instructions in the links below to complete your scan.

[Scanning to a Connected Computer](#)

[Scanning to an Email](#)

[Scanning to a Network Folder or FTP Server](#)

[Scanning to the Cloud](#)

[Scanning to an External USB Device](#)

[Setting Up a WSD Port \(Windows 7\)](#)

[Scanning Using WSD - Windows](#)

[Scanning Using Presets](#)

[Adding and Assigning Scan Jobs with Document Capture Pro - Windows](#)

[Adding and Assigning Scan Jobs with Document Capture - Mac](#)

**Parent topic:** [Starting a Scan](#)

**Related topics**

[Loading Originals](#)

### **Scanning to a Connected Computer**

You can scan an original from the control panel using jobs created in Document Capture Pro (Windows) or Document Capture (Mac). Set the operation mode on the control panel before scanning.

1. Make sure you installed the product software and connected the product to your computer or network.

**Note:** Restart your computer after installing the product software to enable scanning from the control panel.

2. Place your original on the product for scanning.
3. Select the  home icon, if necessary.
4. Select **Computer**.
5. Select the computer on which you created the jobs in Document Capture Pro or Document Capture.



**Note:** If the product is connected via USB or the operation mode is set to **Server Mode**, you do not need to select a computer.

6. On the **Select Job** screen, select the job you want to use.

**Note:** If you have only created one job, you do not need to select the job.

7. If you want to change the scan settings, tap the  icon and select from the following options:
  - To slow down the scanning speed, set the **Slow** setting to **On**.
  - To stop scanning when a double feed is detected, select **Double Feed Stop Timing** and select a timing option.
  - To skip double feed detection when scanning originals such as envelopes or plastic cards, set the **DFDS Function** setting to **On**.
  - To stop scanning when an original containing staples is detected, select **Paper Protection** and select the setting you want to use.

**Note:** Turning this function on will not always prevent damage to your originals.

- To detect dirt on the glass surface inside the product, select **Glass Dirt Detection** and select the setting you want to use.
8. Select the  icon to view the job settings.
  9. Select the  start icon to start scanning.

Document Capture Pro opens and your product scans the original and sends the scanned file to the connected computer.



**Parent topic:** [Starting a Scan Using the Product Control Panel](#)

**Related tasks**

[Scanning Using Presets](#)

[Entering Characters on the LCD Screen](#)



[Scanning to the Cloud](#)

**Related topics**

[Loading Originals](#)

## Scanning to an Email



You can scan an original and email the scanned file using your product's control panel. You need to have a pre-defined email server before you can scan to email. You can either enter the email address directly on the product's control panel or select an address from the **Contacts** list. Make sure the **Date/Time** and **Time Difference** settings are set correctly so the time stamps on your emails are accurate.

1. Place your original on the product for scanning.
2. Select the  home icon, if necessary.
3. Select **Email**.
4. Select a destination.
5. Do one of the following:
  - To select frequently used addresses, tap the icons displayed on the screen.
  - To enter the email address directly, select **Keyboard**, enter an email address, and select **OK**.
  - To select a contact from the Contacts list, select **Contacts**, select a contact or group, and then select **Close**. You can tap the  icon to create a new contact, or search for a contact in the Contacts list. Enter the search keyword into the box at the top of the screen.
  - To select a recently used contact, select **History**, select a contact, and then select **Close**.

**Note:** The number of recipients you selected is displayed on the right side of the screen. You can send emails to up to 10 contacts and groups. If groups are included in the Contacts list, you can select up to 200 individual addresses in total, taking addresses within the groups into account. Select the address box at the top of the screen to display the list of selected addresses.

6. Select the **Scan Settings** tab, and select the desired settings.

**Note:** Tap the  icon if you want to save your settings as a preset.

7. Tap the  icon and check the product's settings or make changes, if necessary.
8. Select the  start icon to start scanning.

**Parent topic:** [Starting a Scan Using the Product Control Panel](#)

#### **Related tasks**

[Entering Characters on the LCD Screen](#)

[Registering Contacts for Email, Network, or FTP Scanning - Control Panel](#)

[Registering Contacts for Email, Network, or FTP Scanning - Web Config](#)

[Selecting the Date and Time](#)

[Scanning Using Presets](#)

#### **Related topics**

[Loading Originals](#)



### **Scanning to a Network Folder or FTP Server**

You can scan an image and save it to a network folder on your computer or on an FTP server using your product's control panel. You can either enter the folder path directly on the product's control panel or select a folder from the Contacts list.

**Note:** Before scanning, make sure you set a network folder or FTP server, and check that the **Date/Time** and **Time Difference** settings are correct.

1. Place your original on the product for scanning.
2. Select the  home icon, if necessary.
3. Select **Network Folder/FTP**.
4. Do one of the following to enter a folder location:
  - To select frequently used addresses, tap the icons displayed on the screen.
  - To enter the folder path directly, select **Keyboard > Communication Mode**, and enter the folder path in the **Location (Required)** field. Select other options, as necessary.

- To select a contact from the Contacts list, select **Contacts**, select a contact, and then select **Close**. You can tap the  icon to create a new contact, or search for a folder from the Contacts list. Enter the search keyword into the box at the top of the screen.
5. Select the **Scan Settings** tab, and select the desired settings.
 

**Note:** Tap the  icon if you want to save your settings as a preset.
  6. Tap the  icon and check the scanner settings or make changes, if necessary.
  7. Select the  start icon to start scanning.

**Parent topic:** [Starting a Scan Using the Product Control Panel](#)

#### **Related tasks**

[Creating a Shared Network Folder](#)

[Registering Contacts for Email, Network, or FTP Scanning - Control Panel](#)

[Registering Contacts for Email, Network, or FTP Scanning - Web Config](#)

[Selecting the Date and Time](#)

### **Scanning to the Cloud**

You can use the control panel to send your scanned files to a destination that you have registered with Epson Connect.



**Note:** Make sure to set up your product using Epson Connect before using this feature.

1. Place your original on the product for scanning.
2. Select the  home icon, if necessary.
3. Select **Cloud**.

**Note:** You must register your product with Epson Connect to select a destination.

4. Tap the + icon at the top of the screen to select a destination.
5. Change any of the displayed settings on the **Basic Settings** tab as necessary.
6. Select the **Advanced** tab to view and change additional scan settings, if necessary.

**Note:** Tap the  icon if you want to save your settings as a preset.

7. Tap the  icon and check the product's settings or make changes, if necessary.
8. Select the  start icon to start scanning.

Your product scans your original and saves the scanned file to the selected destination.

**Parent topic:** [Starting a Scan Using the Product Control Panel](#)

**Related tasks**

[Setting Up Epson Connect Services](#)

[Scanning Using Presets](#)

**Related topics**

[Loading Originals](#)

### Scanning to an External USB Device

You can scan an original and save the scanned image to an external USB device.

1. Place your original on the product for scanning.
2. Select the  home icon, if necessary.
3. Insert a USB device into the product's external interface USB port.

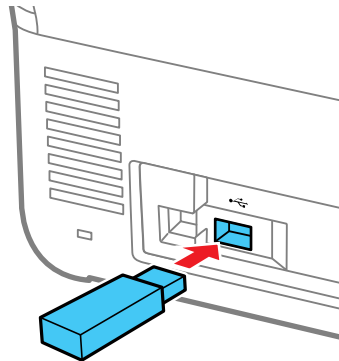



**Note:** Your USB device must meet the following maximum capacity specification: 2 TB (formatted in FAT, FAT32, or exFAT). Devices with security settings (such as password or encryption), or those requiring a dedicated driver cannot be used.

4. Select **USB Drive**.
5. Change any of the displayed settings on the **Basic Settings** tab as necessary.

6. Select the **Advanced** tab to view and change additional scan settings, if necessary.

**Note:** Tap the  icon if you want to save your settings as a preset.

7. Tap the  icon and check the product's settings or make changes, if necessary.
8. Select the  start icon to start scanning.

Your product scans your original and saves the scanned file to the external USB device.

**Parent topic:** [Starting a Scan Using the Product Control Panel](#)

#### **Related tasks**

[Scanning Using Presets](#)

#### **Related topics**

[Loading Originals](#)

### **Setting Up a WSD Port (Windows 7)**

You can scan to a networked Windows computer using WSD (Web Services for Devices). You must first set up a WSD port on your Windows 7 system (the port is set up automatically on Windows 11, Windows 10, and Windows 8.x).

Before you set up a WSD port, make sure you installed your product software, and connected your product and computer to the same network.

1. Turn on your product.
2. Click  and select **Computer**.
3. On the left side of the window, select **Network**.
4. Locate your product on the Network screen, right-click it, and select **Install**.
5. When you see the User Account Control screen, click **Continue**.

**Note:** If you see an Uninstall screen, click **Uninstall** and repeat these steps as necessary.

6. When you see the message **Your device is ready to use** in the Windows taskbar, click the message.
7. On the Driver Software Installation screen, make sure your product is listed as **Ready to use**. Then click **Close**.
8. Click  and select **Devices and Printers**.

9. Make sure that an icon appears for your product's name on the network.



When you use WSD, select your product name to scan over the network.

**Parent topic:** [Starting a Scan Using the Product Control Panel](#)

### Scanning Using WSD - Windows

You can scan originals to a computer from the product control panel using WSD (Web Services for Devices) for network scanning in Windows.

**Note:** To use this feature on Windows 7, you must first set up WSD on the computer. See Windows help for instructions.

1. Make sure you installed the product software and connected the product to your computer or network.
2. Place your original on the product for scanning.
3. Select the  home icon, if necessary.
4. Select **WSD**.
5. Select a computer.
6. Select the  start icon to start scanning.

Your product scans your original and saves the scanned file to your computer.



**Parent topic:** [Starting a Scan Using the Product Control Panel](#)

### Related tasks

[Setting Up a WSD Port \(Windows 7\)](#)

### Scanning Using Presets

You can select a registered preset and use it to scan images.

1. Select the  home icon, if necessary.
2. Do one of the following:
  - Select **Presets** on the home screen, and select a setting from the list.
  - Select the  icon on the Scan Settings screen, select **Load Presets**, and then select a preset from the list.
  - If you added the preset icon to the home screen, select the icon.

3. If you see a loading confirmation screen, select **Close**.

**Note:** If you enabled the **Quick Send** setting for the selected preset, loading is skipped and scanning starts immediately.

4. If you see a loading confirmation screen, select **Close**.
5. Verify the settings for the selected preset and select the  start icon to start scanning.

**Parent topic:** [Starting a Scan Using the Product Control Panel](#)



#### **Related tasks**

[Registering Presets](#)

### **Adding and Assigning Scan Jobs with Document Capture Pro - Windows**

You can add scan jobs that contain specific scan settings and use the jobs when you scan from your product control panel or the Job Scan option in Document Capture Pro. You can save up to 30 scan jobs.

**Note:** Settings may vary depending on the software version you are using. Click the **Help** icon in Document Capture Pro at any time for more information.

1. Do one of the following to start Document Capture Pro:
  - **Windows 11:** Click , then search for **Document Capture Pro** and select it.
  - **Windows 10:** Click  and select **Epson Software > Document Capture Pro**.
  - **Windows 8.x:** Navigate to the **Apps** screen and select **Document Capture Pro**.
  - **Windows (other versions):** Click  or **Start**, and select **All Programs** or **Programs**. Select **Epson Software > Document Capture Pro**.

You see the Document Capture Pro window.

2. Select the **Job Scan** tab.

You see a screen like this:

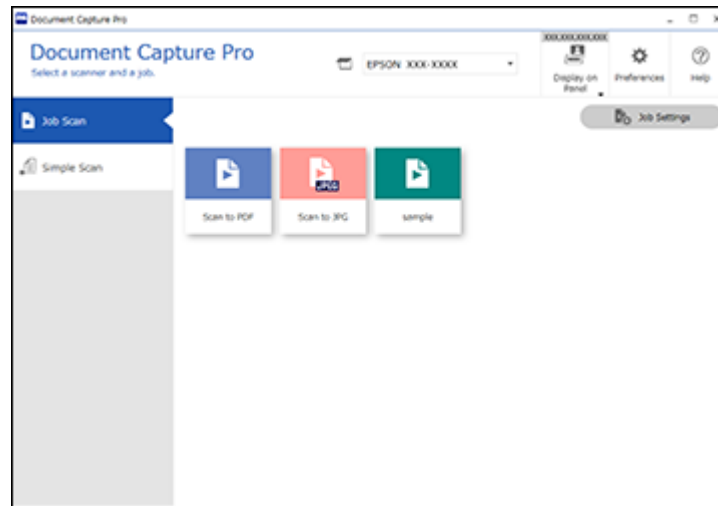

3. Click the **Job Settings** button.

You see a screen like this:

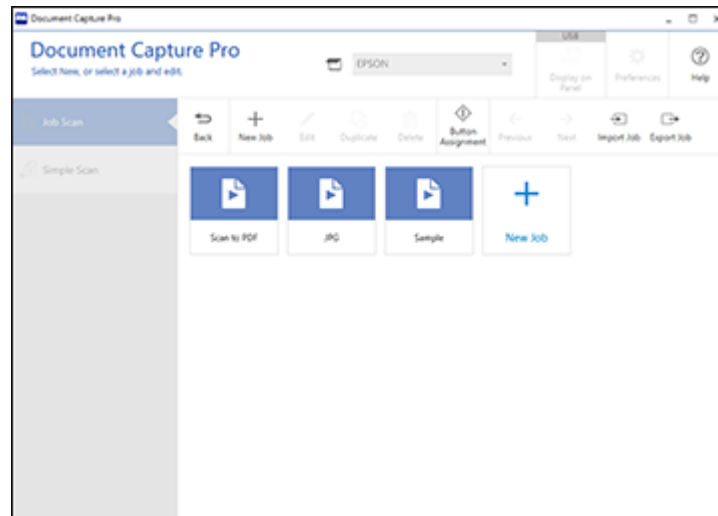



4. To add a scan job, click the **New Job** icon.
5. Enter a name for the new job, and select any settings as necessary from the following options:
  - **Scan**: select the size, color, or resolution
  - **Save**: select the file name, file type, or destination folder
  - **Index**: enable the index setting and choose output options for an index file
  - **Send**: select the destination for the scanned file, or choose to email or print the file
  - **Confirm/Test**: select the job button icon and color, choose display settings, and run a test scan if necessary
6. Click **Save** when you are finished.  
The new job appears in the Job Scan window.
7. To assign a scan job to the product control panel, click the **Button Assignment** icon.  
You see a screen like this:

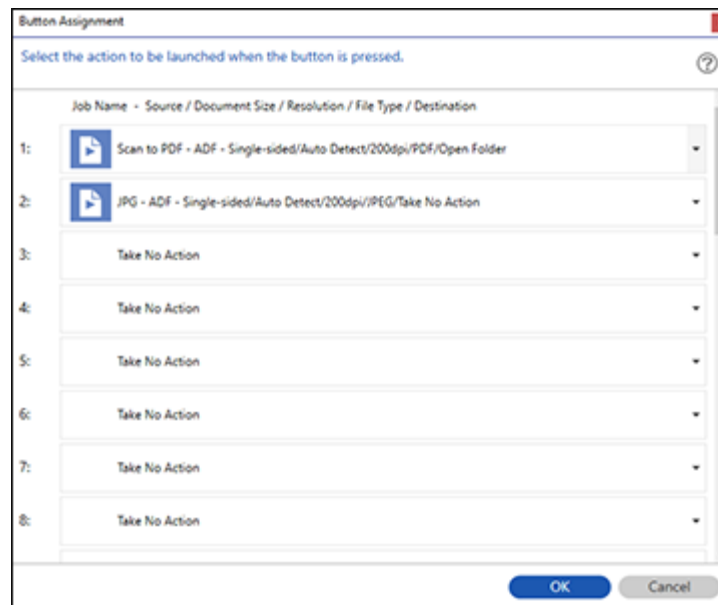

8. Select the jobs that you want to assign to the product control panel using any of the pull-down menus.

**Note:** The number of pull-down menus available may vary, depending on your product and any connected options.

9. Click **OK**, then click **Back**.



You can now use the added scan jobs when you scan from the product control panel.

**Parent topic:** [Starting a Scan Using the Product Control Panel](#)

### **Adding and Assigning Scan Jobs with Document Capture - Mac**

You can add scan jobs that contain specific scan settings and use the jobs when you scan from your product control panel or Document Capture. You can save up to 30 scan jobs.

**Note:** Settings may vary depending on the software version you are using. See the **Help** menu in Document Capture at any time for more information.

1. Start Document Capture on a computer connected to the product.
2. Click the  Manage Job icon from the toolbar at the top of the window.  
You see a window showing the current scan job list.
3. To add a scan job, click the **+** icon, enter a name for the new job, select settings as necessary, and click **OK**.  
You can now use the new scan job when you scan with Document Capture.
4. To assign a scan job to the product control panel, click the  settings icon at the bottom of the window and click **Event Settings**.
5. Select the jobs that you want to assign to the product control panel using any of the pull-down menus.

**Note:** The number of pull-down menus available may vary, depending on your product and any connected options.

6. Click **OK**, then click **OK** again.



You can now use the added scan jobs when you scan from the product control panel.

**Parent topic:** [Starting a Scan Using the Product Control Panel](#)

## Starting a Scan Using the Epson Scan 2 Icon

You can start the Epson Scan 2 program to select scan settings, scan, and save the scanned image to a file.

**Note:** If you are using your Epson product with the Windows 10 S operating system, you cannot use the software described in this section. You also cannot download and install any Epson product software from the Epson website for use with Windows 10 S; you must obtain software only from the Windows Store.

- **Windows 11:** Click , then search for **Epson Scan 2** and select it.
- **Windows 10:** Click  and select **EPSON > Epson Scan 2**.
- **Windows 8.x:** Navigate to the **Apps** screen and select **Epson Scan 2**.
- **Windows (other versions):** Click  or **Start**, and select **All Programs** or **Programs**. Select **EPSON > Epson Scan 2 > Epson Scan 2**.
- **Mac:** Open the **Applications** folder, open the **Epson Software** folder, and select **Epson Scan 2**.

You see an Epson Scan 2 window like this:

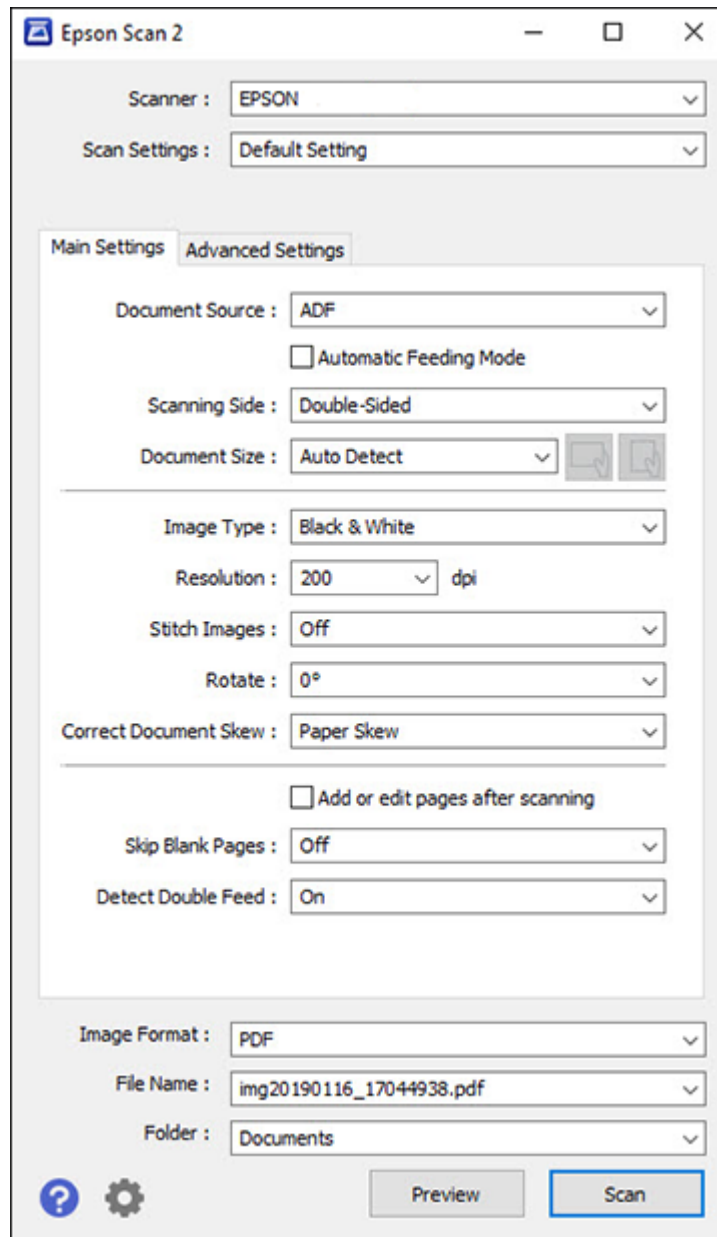

Parent topic: [Starting a Scan](#)

## Starting a Scan from a Scanning Program

You can start Epson Scan 2 from a TWAIN-compliant scanning program to select scan settings, scan, and open the scanned image in the program.

**Note:** If you are using your Epson product with the Windows 10 S operating system, you cannot use the software described in this section. You also cannot download and install any Epson product software from the Epson website for use with Windows 10 S; you must obtain software only from the Windows Store.

1. Open your scanning program and select its scanning option. (See your scanning program help for instructions.)
2. Select your product.

**Note:** In certain programs, you may need to select your product as the "source" first. If you see a **Select Source** option, choose it and select your product. With Windows, do not select a **WIA** option for your product; not all scan functions will be available.

You see an Epson Scan 2 window like this:

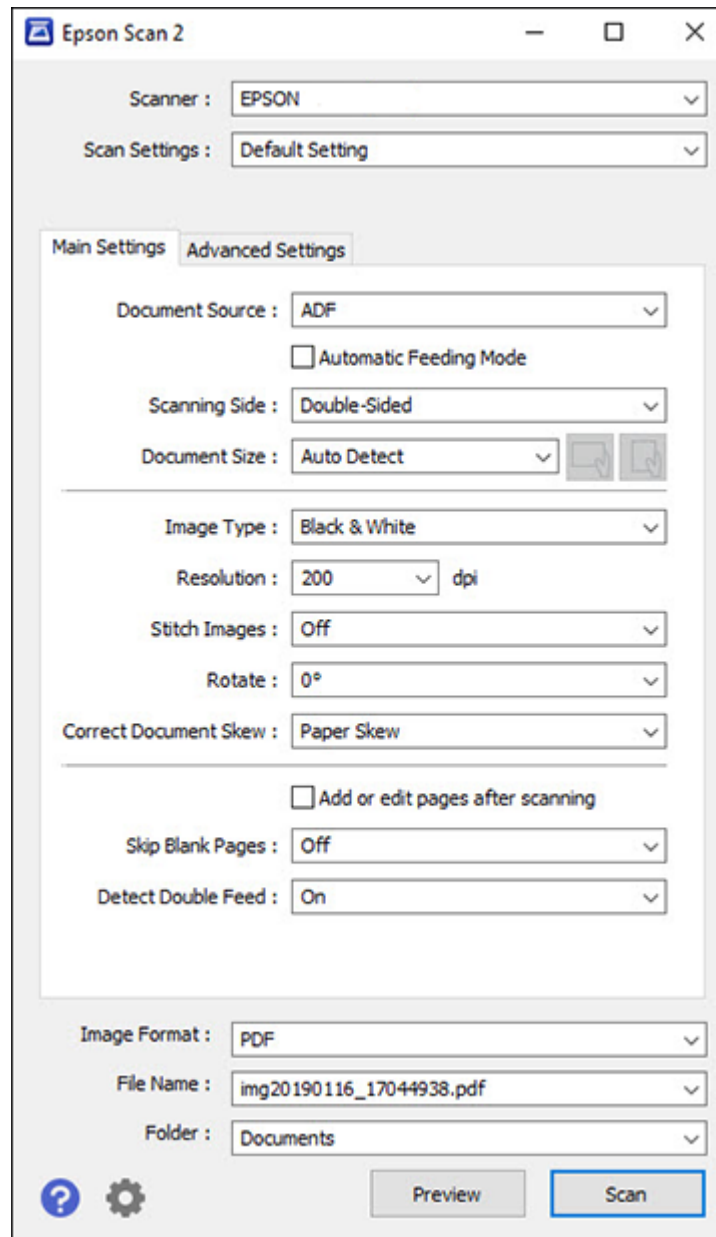

Parent topic: [Starting a Scan](#)

## Starting a Scan from a Smartphone or Tablet

You can use the Epson Smart Panel app to scan from a network scanner to an iOS or Android device over a direct Wi-Fi connection.

**Note:** Epson Smart Panel does not support scanning with a carrier sheet, or scanning originals longer than 15.5 inches (393.7 mm).

1. Download the Epson Smart Panel app from your device's app store or from Epson's website. See the link below.
2. Place your original on the product for scanning.
3. Open the Epson Smart Panel app and select a scan menu on the home screen.
4. Follow the on-screen instructions to scan and save your original.

Parent topic: [Starting a Scan](#)

### Related tasks

[Using the Epson Smart Panel Mobile App](#)

## Scanning with Document Capture Pro or Document Capture

When you scan with Document Capture Pro (Windows) or Document Capture (Mac), the program automatically saves your scanned file on your computer in the folder you specify. You can preview and edit the scanned file, change the scanned file settings, and send to a destination if necessary.

[Setting the Operation Mode on the Product Control Panel](#)

[Scanning with Simple Scan in Document Capture Pro - Windows](#)

[Scanning with Job Scan in Document Capture Pro - Windows](#)

[Scanning with Document Capture - Mac](#)

Parent topic: [Starting a Scan](#)

### Setting the Operation Mode on the Product Control Panel

Before scanning, set the operation mode on the control panel.

1. Make sure you installed the product software and connected the product to your computer or network.
2. Select the  home icon, if necessary.
3. Select **Settings**.



4. Scroll down and select **Document Capture Pro**.
5. Select **Operation Mode**.
6. Choose from the following options:
  - Select **Client Mode** if your product is connected to the network with Document Capture Pro or Document Capture software running on a Windows or macOS Client PC.
  - Select **Server Mode** if your product is connected to the network with Document Capture Pro Server (DCPS) running on a Microsoft-based Server OS. You need to enter the server address in this mode.
7. Select **OK > Close** to return to the Settings menu.

**Parent topic:** [Scanning with Document Capture Pro or Document Capture](#)

### Scanning with Simple Scan in Document Capture Pro - Windows

You can use the Simple Scan option in Document Capture Pro to quickly scan an original.

**Note:** Settings may vary depending on the software version you are using. Click the **Help** icon in Document Capture Pro at any time for more information.

1. Load your original in the product.
2. Do one of the following to start Document Capture Pro:
  - **Windows 11:** Click , then search for **Document Capture Pro** and select it.
  - **Windows 10:** Click  and select **Epson Software > Document Capture Pro**.
  - **Windows 8.x:** Navigate to the **Apps** screen and select **Document Capture Pro**.
  - **Windows (other versions):** Click  or **Start**, and select **All Programs** or **Programs**. Select **Epson Software > Document Capture Pro**.

You see the Document Capture Pro window.

**Note:** You may need to select your scanner from the list, if necessary.

3. Select the **Simple Scan** tab.



You see a window like this:

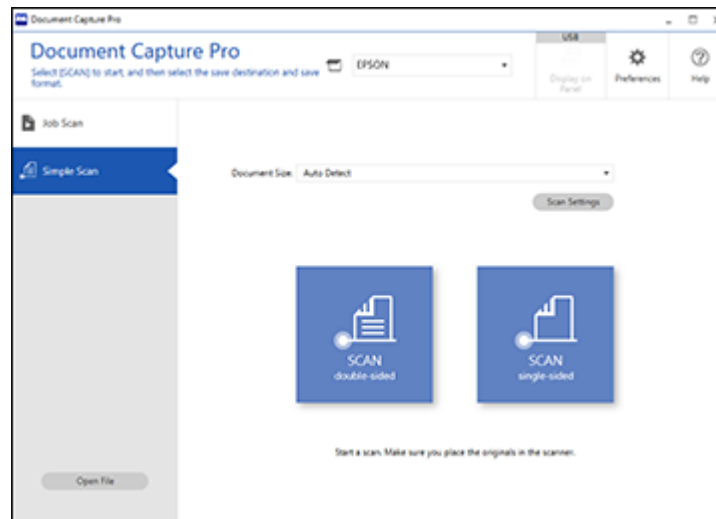

4. Select the size of your original from the **Document Size** menu.
5. If you want to change specific settings for the scan, click the **Scan Settings** button. Change any of the settings as necessary and click **OK**. For additional settings, click the **Detailed Settings** button on the Scan Settings screen.
6. Do one of the following:
  - To scan both sides of an original, select **SCAN double-sided**.
  - To scan the front side of an original, select **SCAN single-sided**.

Your product scans the original and the image appears in the Edit Scanned Results window.

7. Review and edit the scanned image as necessary and click **Next** when you are finished.
8. Select a destination for the scanned image, change any settings as necessary, and click **Complete**.



**Note:** If you are sending the scanned image to a server or cloud destination, you need to enter your login information.

**Parent topic:** [Scanning with Document Capture Pro or Document Capture](#)

## Scanning with Job Scan in Document Capture Pro - Windows

You can create scan jobs in Document Capture Pro and use them to quickly scan originals and save them to various destinations.

**Note:** Settings may vary depending on the software version you are using. Click the **Help** icon in Document Capture Pro at any time for more information.

1. Load your original in the product.
2. Do one of the following to start Document Capture Pro:
  - **Windows 11:** Click , then search for **Document Capture Pro** and select it.
  - **Windows 10:** Click  and select **Epson Software > Document Capture Pro**.
  - **Windows 8.x:** Navigate to the **Apps** screen and select **Document Capture Pro**.
  - **Windows (other versions):** Click  or **Start**, and select **All Programs** or **Programs**. Select **Epson Software > Document Capture Pro**.

You see the Document Capture Pro window.

**Note:** You may need to select your scanner from the list, if necessary.

3. Select the **Job Scan** tab.

You see a window like this:

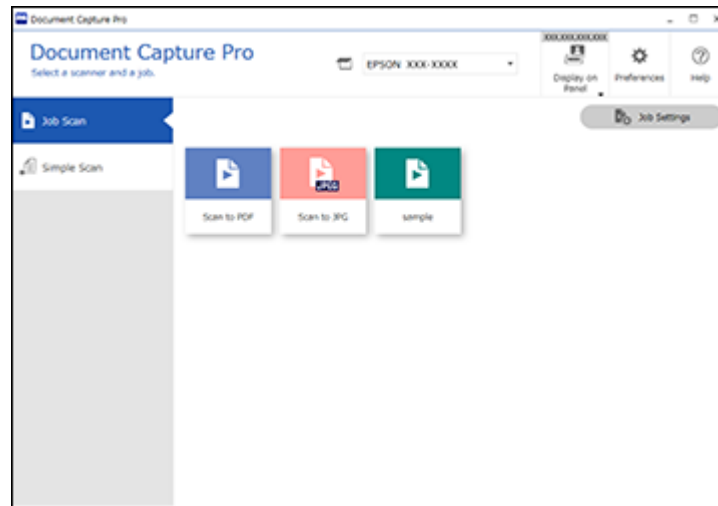

4. Select one of the scan jobs (or click **Job Settings** to create a new scan job).  
The product scans the loaded original and saves it according to the job settings.
5. Depending on the settings for the scan job you selected, you may be able to view and edit the pages before saving them. If so, click **Complete** when finished.  
The scanned image is saved according to the job settings.

**Parent topic:** [Scanning with Document Capture Pro or Document Capture](#)

### Scanning with Document Capture - Mac

When you scan with Document Capture, the program automatically saves your scanned file on your computer in the folder you specify. You can select settings, preview, and change the scanned file settings as necessary. Document Capture also allows you to send the scanned file directly to an email address or printer, or upload it to a server or cloud destination.

**Note:** Settings may vary depending on the software version you are using. See the **Help** menu in Document Capture at any time for more information.

1. Load your original in the product.
2. Open the **Applications** folder, open the **Epson Software** folder, and select **Document Capture**.

You see a window like this:

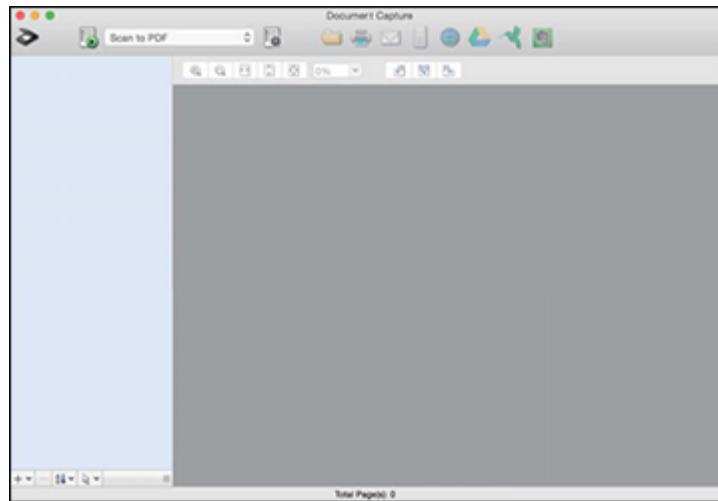

**Note:** You may need to select your product from the drop-down list.

3. Click the  scan icon.

You see a window like this:

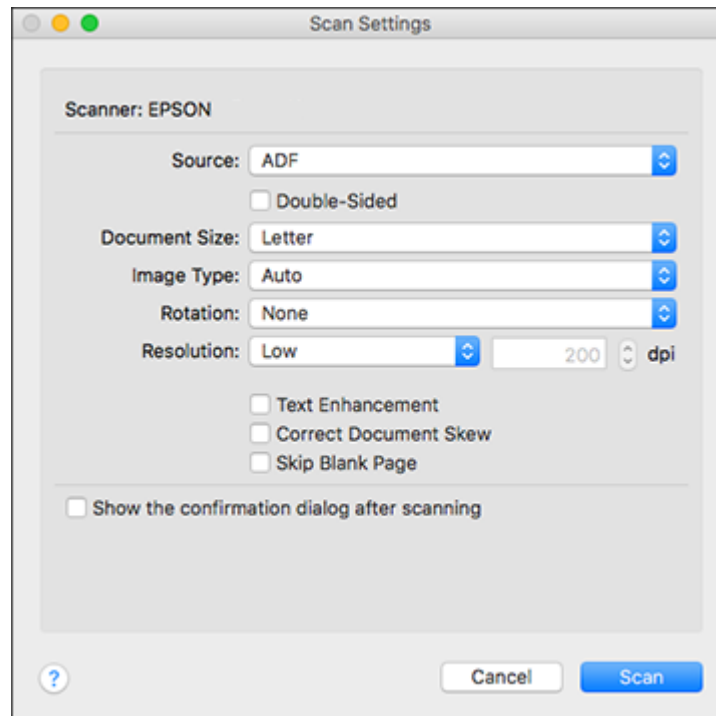

**Note:** If you want to use a scan job that you created instead, select it from the Job list in the Document Capture window, click the  Start Job button, and skip the rest of these steps.

4. Select any displayed scan settings you want to use.

**Note:** See the Help information in Document Capture for details.

5. If you want to select detailed scan settings, close the Scan Settings window, open the **Scan** menu at the top of the Mac desktop, and select **Displays the EPSON Scan Setup Screen**.
6. Click the  Scan icon and select any detailed scan settings you want to use from the Epson Scan 2 window.
7. Click **Scan**.

You see a preview of your scan in the Document Capture window.

**Note:** You may have to close the Epson Scan 2 window to view your scan in the Document Capture window.

8. If you would like to scan additional originals and add them to the current captured images, click the + icon, select **Acquire from Scanner**, and repeat the previous steps.
9. Check the scanned images and edit them as necessary.
10. Click one of the destination icons to choose where to send your scanned files. (If you cannot see all of the icons, click the arrow next to the icons.) Change any settings as necessary.



**Note:** If you are sending the scanned image to a server or cloud destination, you need to enter your login information. If you want to use Evernote as the destination, download the Evernote application from the Evernote Corporation website and install it before scanning.

11. Depending on the destination you chose, click **OK** or **Send** to complete the operation.

**Parent topic:** [Scanning with Document Capture Pro or Document Capture](#)

## Scanning in Epson Scan 2

Epson Scan 2 gives you access to basic and advanced scanning features. You can scan your document and save the scanned image in various file formats in your operating system's Documents or My Documents folder, or open it in your scanning program. You can preview the scanned image and select or change settings as necessary.

1. Load your original in the product.
2. Start Epson Scan 2.

You see this window:

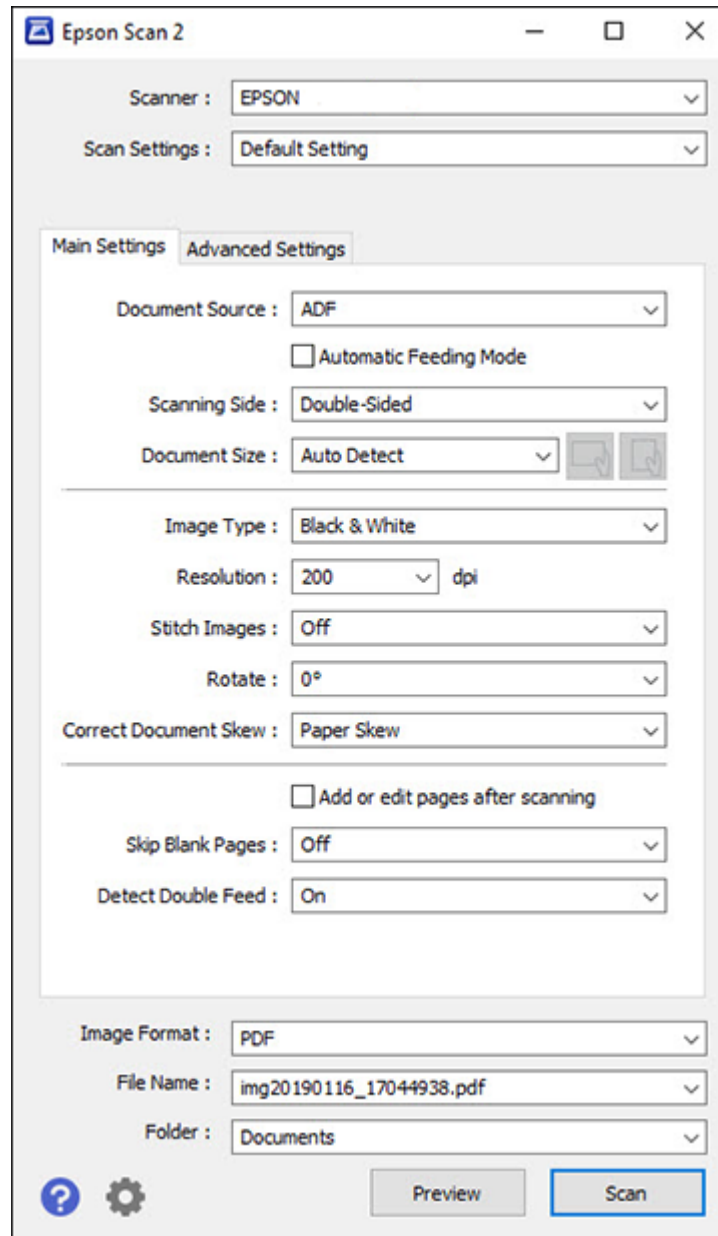

**Note:** The **Document Source** setting is automatically set to **ADF** for your product.

3. If you want to scan different size originals by loading them into the ADF one by one, check the **Automatic Feeding Mode** checkbox. Scanning begins as soon as you load each original.
4. Select the **Scanning Side** setting that matches the sides of the original that you want to scan.
5. Select the **Document Size** setting that matches the size of your original, or select **Auto Detect** to have Epson Scan 2 automatically detect the size. You can select **Customize** to enter a custom size, if necessary.
6. Click on one of the orientation icons, if applicable.
7. Select your original image type and how you want it scanned as the **Image Type** setting.
8. Select the **Resolution** setting you want to use for your scan.
9. Select any of the additional settings that you want to use on the **Main Settings** tab.
10. Click the **Advanced Settings** tab and select any settings that you want to use.
11. To see a preview of your scan with the settings you selected, click the **Preview** button.



Epson Scan 2 previews your original and displays the results in the Epson Scan 2 window.

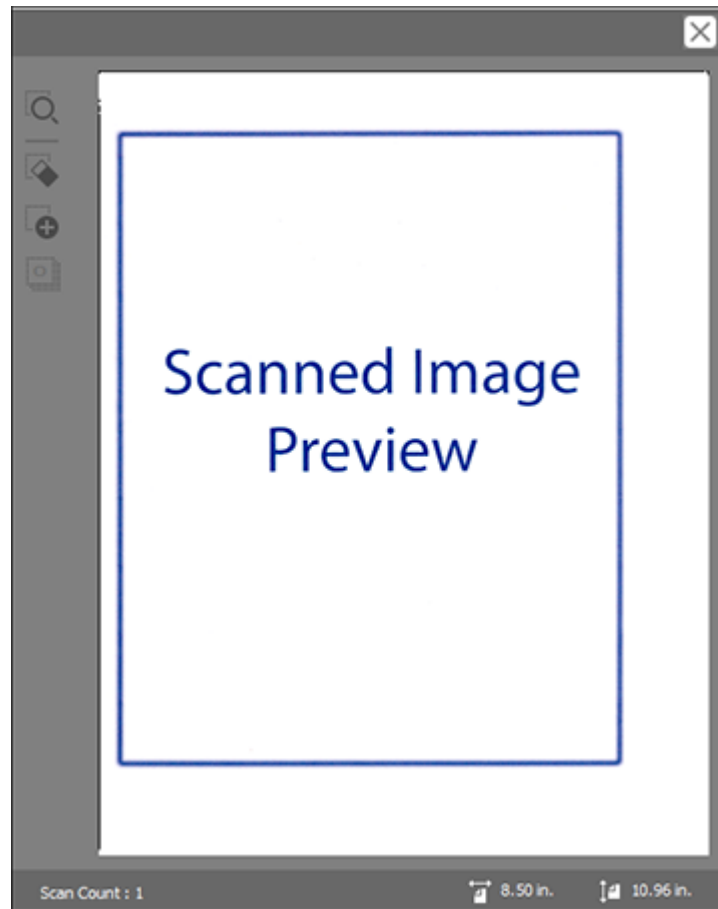

12. Reinsert your original into the ADF.
13. If scanning an original in a carrier sheet or other special original, see the link at the end of this section for other setting requirements for special documents.
14. Select the format in which you want to save your scanned file as the **Image Format** setting. If necessary, select **Options** and select any desired format options.
15. Select **Settings** to modify the file name settings. Enter the file name for your scanned file in the **File Name** field.

16. Select the location in which you want to save your scanned file as the **Folder** setting. If necessary, select **Select** to choose an alternate folder or create a new folder.

17. Click **Scan**.

The product scans your original and saves the scanned file in the location you specified.

18. If you selected the **Automatic Feeding Mode** setting, place your next original in the ADF for scanning. When you finish scanning originals, click **Finish**.

[Additional Scanning Settings - Main Settings Tab](#)

[Additional Scanning Settings - Advanced Settings Tab](#)

[Scanning Settings for Special Documents](#)

[Saving Scanned Documents as a Searchable PDF Using Epson Scan 2](#)

[Image Format Options](#)

**Parent topic:** [Starting a Scan](#)

**Related tasks**

[Loading Originals in the Input Tray](#)

### **Additional Scanning Settings - Main Settings Tab**

You can select these additional scanning settings on the Epson Scan 2 Main Settings tab.

#### **Stitch Images**

When scanning double-sided originals, lets you lay out images from both sides of the original onto one scanned page.

#### **Rotate**

Rotates the original image clockwise to the desired angle before scanning it. Select **Auto** to allow your product to automatically rotate the image based on the orientation of the text (may take longer to scan).

#### **Correct Document Skew**

Corrects skewed originals, image contents, or both.

#### **Add or edit pages after scanning**

Lets you add, remove, or edit the pages in a scan, including rotating pages and changing the page order.

**Note:** To save multiple pages in a single file, you must select a file format that supports multiple pages such as **PDF** or **Multi-TIFF**. If you select another file format, each scanned image or page is saved as a separate file.

**Skip Blank Pages**

If the scanner detects marks from the other side of a blank page and adds the marks to the scanned image, adjust this setting to prevent this.

**Detect Double Feed**

Detects a double-feed paper error in the ADF. If you are scanning an original envelope or plastic card, select **Off**.

Parent topic: [Scanning in Epson Scan 2](#)

**Additional Scanning Settings - Advanced Settings Tab**

You can select these additional scanning settings on the Epson Scan 2 Advanced Settings tab. Not all adjustment settings may be available, depending on other settings you have chosen.

**Remove Background**

Removes the background of the originals.

**Text Enhancement**

Sharpens the appearance of letters in text documents.

**Auto Area Segmentation**

Makes black and white images clearer and text recognition more accurate by separating the text from the graphics.

**Dropout**

The scan will not pick up the color you select. This setting is available only if you select **Grayscale** or **Black & White** as the Image Type setting.

**Color Enhance**

Enhances the shades of the color you select in the scanned image. This setting is available only if you select **Grayscale** or **Black & White** as the Image Type setting.

**Brightness**

Adjusts the overall lightness and darkness of the scanned image.

**Contrast**

Adjusts the difference between the light and dark areas of the overall scanned image.

**Gamma**

Adjusts the midtone density of the scanned image.

**Unsharp Mask**

Makes the edges of certain image areas clearer. Turn off this option to leave softer edges.

**Descreening**

Removes the ripple pattern that might appear in subtly shaded image areas, such as skin tones. This option improves results when scanning magazines or newspapers. (The results of descreening do not appear in the preview image, only in your scanned image.)

**Threshold**

Adjusts the level at which black areas in text and line art are delineated, improving text recognition in OCR (Optical Character Recognition) programs.

**Edge Fill**

Corrects shadowing around the edges of the image by filling the shadows with black or white.

**Remove Punch Holes**

Removes the shadows caused by holes on the edges of the original.

**Dual Image Output**

Scans the original image twice using different output settings (Windows only).

**Watermark**

Adds text to the background of the scanned image.

Parent topic: [Scanning in Epson Scan 2](#)

**Scanning Settings for Special Documents**

You need to select specific options on the Main Settings tab in Epson Scan 2 when scanning special originals.

Type of original	Required settings
Envelope	Select <b>Off</b> as the <b>Detect Double Feed</b> setting.
Plastic cards	Select <b>Plastic Card</b> as the <b>Document Size</b> setting.
Carrier sheet	If you select <b>Auto Detect</b> as the <b>Document Size</b> setting, paper skew is automatically corrected even if the <b>Correct Document Skew</b> setting is set to <b>Off</b> .  If you select a setting other than <b>Auto Detect</b> as the <b>Document Size</b> setting, you can only use <b>Contents Skew</b> as the <b>Correct Document Skew</b> setting. As paper skew is not applied in this case, only contents skew is corrected when you select the <b>Paper and Contents Skew</b> setting.
Large originals	If the <b>Document Size</b> list does not contain the document size you want to scan, select <b>Customize</b> to create a custom size.

Type of original	Required settings
Long paper	<p>If the <b>Document Size</b> list does not contain the document size you want to scan, choose one of the following depending on the length of the original:</p> <p>If the paper length is 120 inches (3048 mm) or less, select <b>Auto Detect (Long Paper)</b> to detect the size automatically.</p> <p>If the paper length is more than 120 inches (3048 mm), select <b>Customize</b> to create a custom size and either select the <b>Detect paper length</b> checkbox if the paper length is less than 215 inches (5461 mm), or enter a custom <b>Width</b> and <b>Length</b> if the paper is 215 inches (5461 mm) or longer.</p>
Laminated cards	<p>To scan any transparent areas around the edges of the card, select <b>Settings</b> as the <b>Document Size</b> setting and either select the <b>Scan laminated card</b> checkbox or create a custom size.</p>

Parent topic: [Scanning in Epson Scan 2](#)

### Saving Scanned Documents as a Searchable PDF Using Epson Scan 2

You can scan a document and save the text in a searchable PDF. In a searchable PDF, text is recognized using Optical Character Recognition (OCR) and then embedded in the scanned original.

**Note:** The required Epson Scan 2 OCR Component is installed automatically when you install your product software. If you install your product software programs individually, be sure to also install this component if you want to perform OCR.

1. Load your original in the product for scanning.
2. Start Epson Scan 2.
3. Select your scan settings.
4. Click **Preview** and adjust the area you want to scan, if necessary.
5. Reload the ejected original in the scanner.
6. Select **Searchable PDF** as the Image Format setting.
7. Select **Options** from the Image Format list.

You see this window:

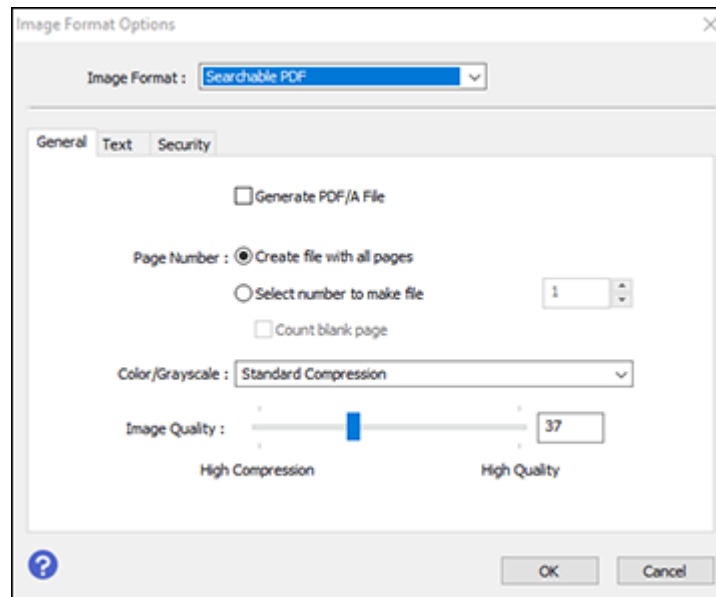

8. Select any of the options on the General tab.
9. Select the **Text** tab.
10. Make sure the language used in the document text is selected as the **Text Language** setting.
11. Select the **Security** tab if you want to add a password to the PDF or protect printing or editing properties.
12. Click **OK**.
13. Confirm the **File Name** setting and select a **Folder** setting for your document.
14. Click **Scan**.

The scanned image is saved as a searchable PDF.

**Parent topic:** [Scanning in Epson Scan 2](#)

### Image Format Options

You can select different image formats and related options. For details on available options, click the ? icon on the Epson Scan 2 Image Format Options window. Not all image formats have options.

**BITMAP (\*.bmp)**

A standard image file format for most Windows programs.

**JPEG (\*.jpg)**

An image format that lets you highly compress image data. However, the higher the compression, the lower the image quality. (The TIFF format is recommended when you need to modify or retouch your scanned image.)

**PNG (\*.png)**

An image format that does not lose quality during editing.

**TIFF (\*.tif)**

A file format created for exchanging data between many programs, such as graphic and DTP software.

**Multi-TIFF (\*.tif)**

A TIFF file format when multiple pages are saved to the same file, allowing you to edit the images using a compatible program.

**PDF (\*.pdf)**

A document format that is readable by Windows and Mac systems using Adobe Reader, Acrobat, or other programs. You can save multi-page documents in one PDF file.

**Searchable PDF (\*.pdf)**

A document format that is readable by Windows and Mac systems using Adobe Reader, Acrobat, or other programs. You can save multi-page documents in one PDF file. Recognized text in the scanned document can be searched.

**Parent topic:** [Scanning in Epson Scan 2](#)

## Scan Resolution Guidelines

The resolution setting in your scanning software, measured in dpi (dots per inch), controls the amount of detail captured in your scans. Increasing the resolution raises the amount of detail captured but comes with the following disadvantages:

- Larger file sizes
- It takes longer to scan your originals, send/receive your scans by email or fax, and to print your scans
- The image may become too large to fit on your display or print on paper

If you plan to enlarge a scanned image so you can print it at a larger size, you may need to increase the resolution from the default resolution set by the software. Follow these guidelines to determine the resolution setting you need:

- You will scan the image at its original size but enlarge it later in an image-editing program.

Increase the resolution setting in your scanning software. Increase the resolution by the same amount you will increase the image size to retain a high image quality. For example, if the resolution is 300 dpi (dots per inch) and you will double the image size later, change the resolution setting to 600 dpi.

- You will scan the image at 100% or smaller size.

Select the resolution setting based on how you will use the scanned image:

- Email/view on a computer screen/post on the web: 96 to 200 dpi
- Print/fax/convert to editable text (OCR)/create searchable PDF: 200 to 300 dpi

**Parent topic:** [Starting a Scan](#)

## Scanning Special Projects

Your product's scanning software offers various options to help you quickly complete special scan projects.

[Scanning Two Originals onto One Sheet \(Stitching Images\) - Windows](#)

[Scanning Multi-Page Originals as Separate Files - Windows](#)

[Saving a Scan as an Office Format File - Windows](#)

[Scanning to a SharePoint Server or Cloud Service - Windows](#)

[Scanning to a SharePoint Server or Cloud Service - Mac](#)

**Parent topic:** [Starting a Scan](#)

### Scanning Two Originals onto One Sheet (Stitching Images) - Windows

You can scan both sides of a double-sided or folded original in Document Capture Pro and combine them into a single image with the Epson Scan 2 Stitch Images setting (not available for all products).

**Note:** Settings may vary depending on the software version you are using. Click the **Help** icon in Document Capture Pro at any time for more information.



1. Load your original in the product.

**Note:** Use an optional carrier sheet when scanning a folded original or damage to the original may occur. Place the original into the carrier sheet with the folded edge against the right side of the carrier sheet. Make sure to insert the carrier sheet into your product with the white edge facing down.

2. Do one of the following to start Document Capture Pro:

- **Windows 11:** Click , then search for **Document Capture Pro** and select it.



- **Windows 10:** Click  and select **Epson Software > Document Capture Pro**.
  - **Windows 8.x:** Navigate to the **Apps** screen and select **Document Capture Pro**.
  - **Windows (other versions):** Click  or **Start** and select **All Programs** or **Programs**. Select **Epson Software > Document Capture Pro**.
3. Select the **Simple Scan** tab.  
You see a window like this:

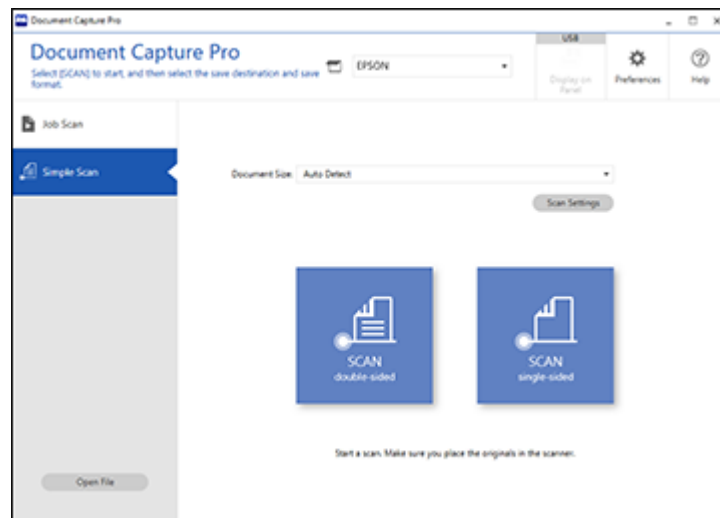

4. Click **Scan Settings > Detailed Settings**.

You see an Epson Scan 2 window like this:

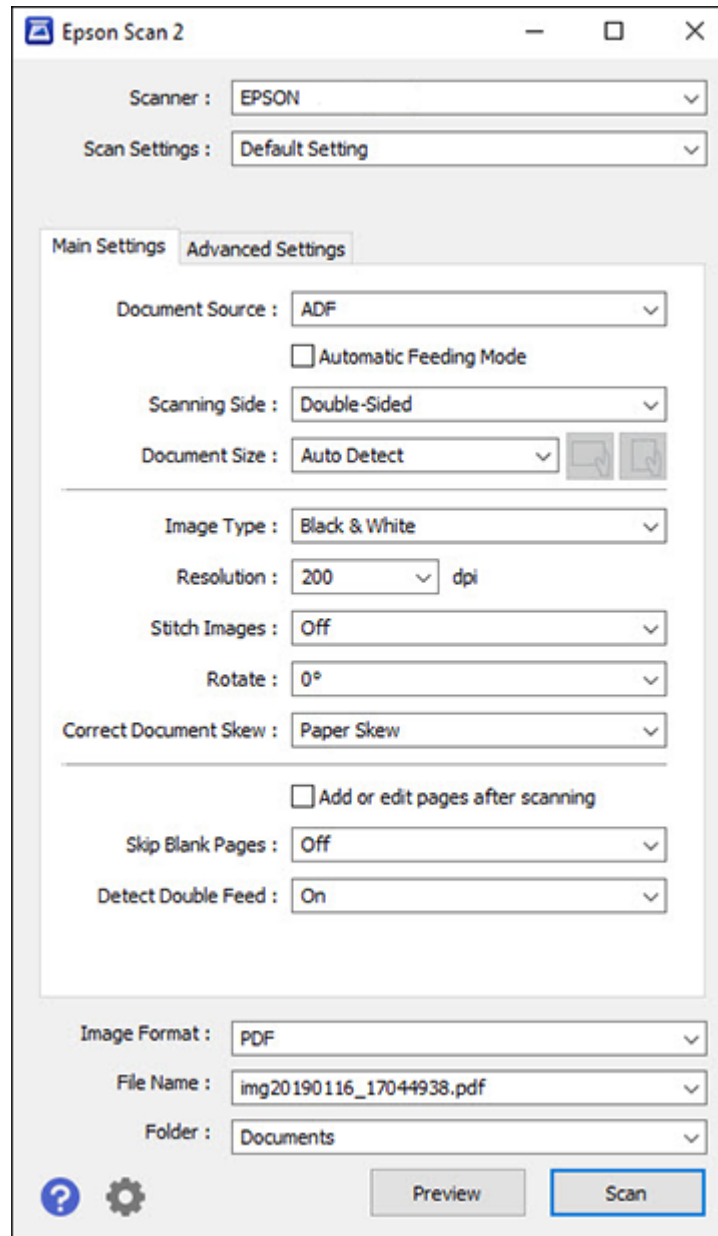

5. Select **Double-Sided** as the **Scanning Side** setting.
6. Select the original document size or **Auto Detect** as the **Document Size** setting.
7. Select one of the following as the **Stitch Images** setting:
  - **Top & Bottom**: Places the scanned images one above the other.
  - **Left & Right**: Places the scanned images side by side.
8. Select the **Advanced Settings** tab and verify that the **Edge Fill** setting is set to **None**.
9. Click **Save**.
10. Click **OK**.
11. Click **SCAN double-sided**.

Your product scans the original and the image appears in the Edit Scanned Results window.

**Note:** If the scanned images are not stitched together in the correct orientation, click **Scanning Side** on the Epson Scan 2 window, select **Settings**, set the Binding Edge to **Left** or **Top**, and rescan the document.



12. Review and edit the scanned pages as necessary and click **Next** when you are finished.
13. Select a destination and any settings as necessary and click **Complete**.

**Parent topic:** [Scanning Special Projects](#)

### Scanning Multi-Page Originals as Separate Files - Windows

You can use Document Capture Pro to scan multi-page originals as separate scanned files. You can indicate how the separate files are created by defining a maximum page count per file or by inserting blank pages, barcodes, or characters that can be detected by the software as separation markers.

**Note:** Settings may vary depending on the software version you are using. Click the **Help** icon in Document Capture Pro at any time for more information.

1. Load your multi-page original in the product.
2. Do one of the following to start Document Capture Pro:
  - **Windows 11:** Click , then search for **Document Capture Pro** and select it.
  - **Windows 10:** Click  and select **Epson Software > Document Capture Pro**.
  - **Windows 8.x:** Navigate to the **Apps** screen and select **Document Capture Pro**.

- **Windows (other versions):** Click  or **Start**, and select **All Programs** or **Programs**. Select **Epson Software > Document Capture Pro**.

You see the Document Capture Pro window.

3. Select the **Job Scan** tab.

You see a window like this:

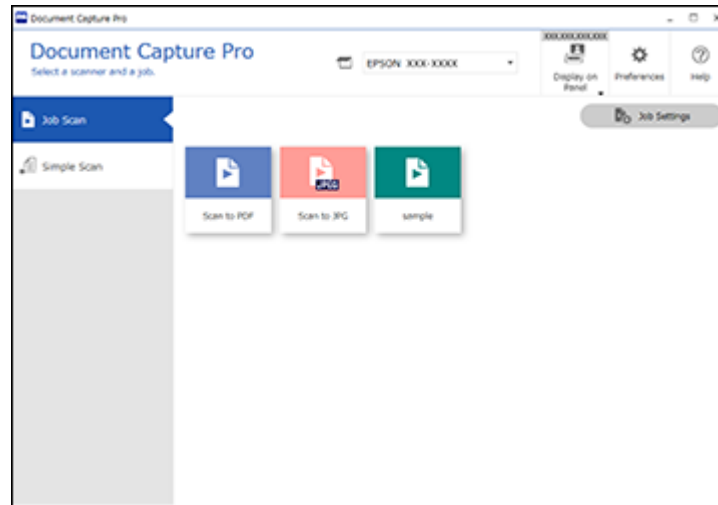

4. Click the **Job Settings** button.

You see a window like this:

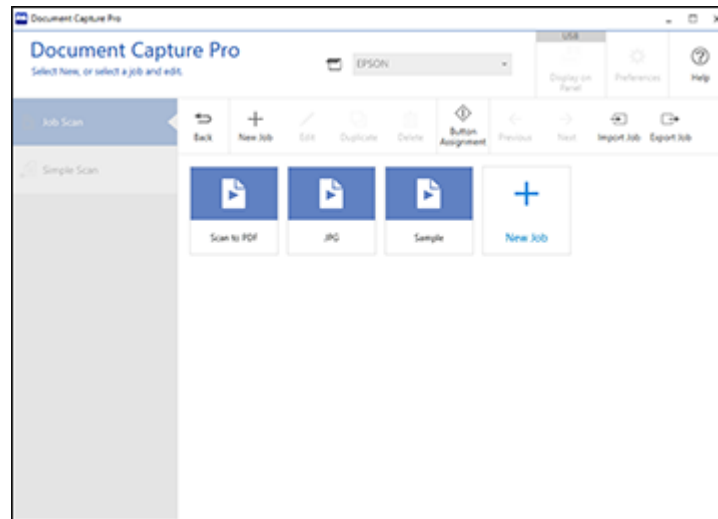

5. Select **New Job** and select the scan settings. Click **Next** when finished.

You see a window like this:

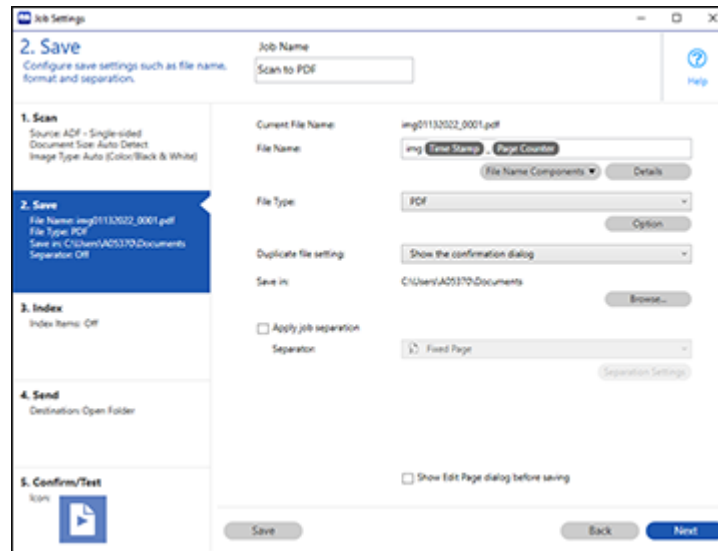

6. Select the **Apply job separation** checkbox.
7. Select the method you want to use to separate the originals as the **Separator** setting. Click **Separation Settings** to specify the settings for the selected option.
8. Finish creating the new scan job and click **Save**.
9. Click **Back** on the Job Settings screen.



Your originals are saved into separate files and folders as specified when the job is run.

**Parent topic:** [Scanning Special Projects](#)

### **Saving a Scan as an Office Format File - Windows**

You can use Document Capture Pro (Windows) to save your scans in one of the following Microsoft Office file formats: Microsoft Word (.docx), Microsoft Excel (.xlsx), or Microsoft PowerPoint (.pptx).

**Note:** The settings may vary, depending on the software version you are using. See the help information in Document Capture Pro for details.

1. Load your original in the product.
2. Do one of the following to start Document Capture Pro:
  - **Windows 11:** Click , then search for **Document Capture Pro** and select it.
  - **Windows 10:** Click  and select **Epson Software > Document Capture Pro**.
  - **Windows 8.x:** Navigate to the **Apps** screen and select **Document Capture Pro**.
  - **Windows (other versions):** Click  or **Start**, and select **All Programs** or **Programs**. Select **Epson Software > Document Capture Pro**.
3. Select the **Simple Scan** tab.

You see a window like this:

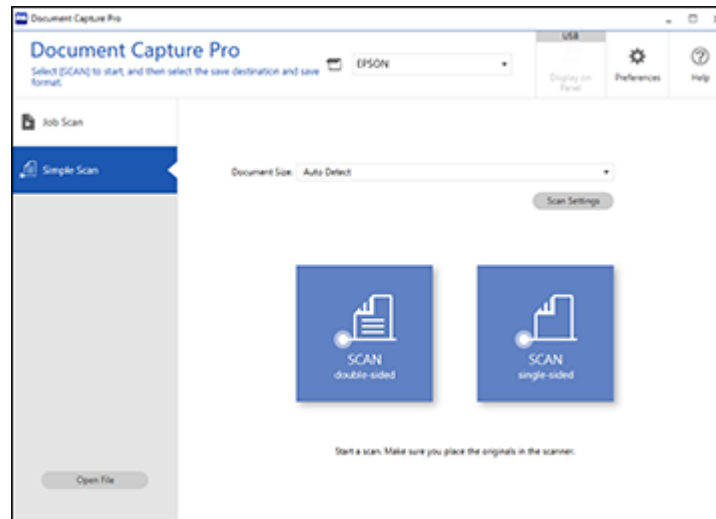

4. If you want to select specific scan settings for the scan, click the **Scan Settings** button, select any displayed settings you want to use, and click **OK**.

**Note:** See the help information in Document Capture Pro for details.

5. Do one of the following:
  - To scan the front side of an original, select **SCAN single-sided**.
  - To scan both sides of an original, select **SCAN double-sided**.

Your product starts scanning and you see the Edit Scanned Results window.

6. View and edit the scanned pages as necessary and click **Next** when you are finished.

**Note:** See the help information in Document Capture Pro for details.

7. Click one of the destination icons (except **Print**) to choose where to send your scanned files. You see the settings window.
8. Select the Office format file you want to use from the **File Type** drop-down list.
9. Click **Option** to display additional settings.

10. Select any additional settings as necessary and click **OK**.

**Note:** See the help information in Document Capture Pro for details.

11. Confirm your settings and click **Complete**.



Your originals are saved in the Office file format you selected.

**Parent topic:** [Scanning Special Projects](#)

### Scanning to a SharePoint Server or Cloud Service - Windows

You can use Document Capture Pro (Windows) to upload scanned images to a SharePoint server or a cloud service.

**Note:** The settings may vary, depending on the software version you are using. See the help information in Document Capture Pro for details.

1. Load your original in the product.
2. Do one of the following to start Document Capture Pro:
  - **Windows 11:** Click , then search for **Document Capture Pro** and select it.
  - **Windows 10:** Click  and select **Epson Software > Document Capture Pro**.
  - **Windows 8.x:** Navigate to the **Apps** screen and select **Document Capture Pro**.
  - **Windows (other versions):** Click  or **Start**, and select **All Programs** or **Programs**. Select **Epson Software > Document Capture Pro**.
3. Select the **Simple Scan** tab.



You see a window like this:

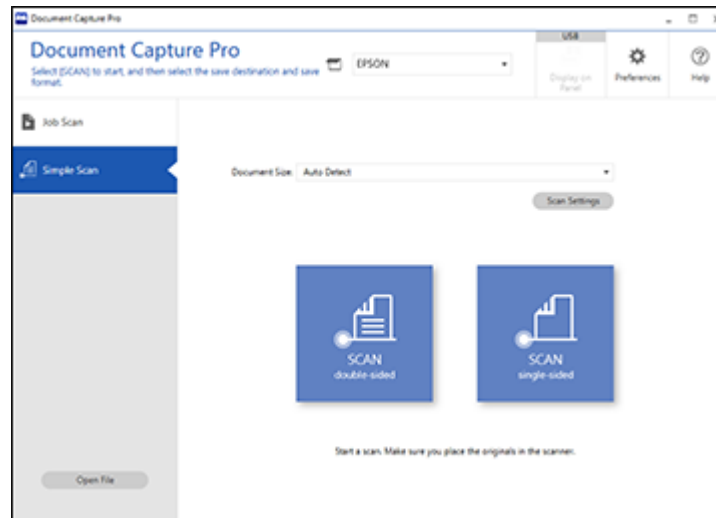

4. If you want to select specific scan settings for the scan, click the **Scan Settings** button, select any displayed settings you want to use, and click **OK**.

**Note:** See the help information in Document Capture Pro for details.

5. Do one of the following:
  - To scan both sides of an original, select **SCAN double-sided**.
  - To scan the front side of an original, select **SCAN single-sided**.

Your product starts scanning and you see the Edit Scanned Results window.

6. View and edit the scanned pages as necessary and click **Complete** when you are finished.

**Note:** See the help information in Document Capture Pro for details.

7. Click one of the cloud server or service destination icons. You see the settings window.
8. Enter any required information to set up the destination. You may need to log in to your cloud service to authenticate the connection and allow Document Capture Pro to access the cloud service.

9. Adjust any settings and click **Complete**.

**Note:** See the help information in Document Capture Pro for details.

Your originals are uploaded to the indicated server or cloud service.

**Parent topic:** [Scanning Special Projects](#)

### Scanning to a SharePoint Server or Cloud Service - Mac

You can use Document Capture to upload scanned images to a SharePoint server or a cloud service.

**Note:** The screen shown may vary, depending on your OS version.

1. Open the **Applications** folder, open the **Epson Software** folder, and select **Document Capture**.

You see a window like this:

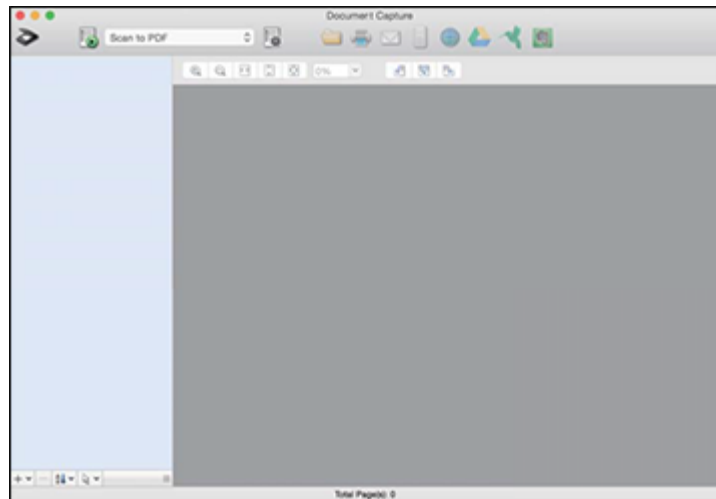

**Note:** You may need to select your product from the drop-down list.

2. Click the  scan icon.
3. Select any displayed scan settings you want to use.

**Note:** See the Help information in Document Capture for details.

4. Click **Scan**.

You see a preview of your scan in the Document Capture window.

5. Click one of the cloud service Destination icons to choose where to save your scanned file. (If you cannot see all of the icons, the service software may not be installed, the service may not be available on your platform, or you need to click the arrow next to the icons.)

You see the Transfer Settings window.

6. Enter any required information to set up the destination. You may need to log in to your cloud service to authenticate the connection and allow Document Capture to access the cloud service. If you have previously created a saved setting for the destination, select it from the drop-down list.
7. Adjust any save settings, then click **OK** or **Send**, depending on the destination.

Your originals are scanned and uploaded to the indicated server or cloud service.

**Parent topic:** [Scanning Special Projects](#)

## Scanning with AirPrint

AirPrint enables instant scanning from a Mac without the need to install drivers or download software.



**Note:** You can only scan using AirPrint on a macOS system. The iOS operating system does not support scanning with AirPrint.

1. Load your originals.
2. Connect the product to the same network that your Mac is connected to, or connect the product to your Mac with a USB cable.
3. On the **System Preferences** screen on your Mac, click **Printers & Scanners**.
4. Select your scanner from the list, then click **Open Scanner**.
5. Select scan settings as needed, then start scanning.

**Note:** For details, see the macOS User Guide.

**Parent topic:** [Starting a Scan](#)

## Related topics

[Loading Originals](#)

## Authentication Scanning

Your product comes with an authentication feature which provides standalone authentication without using a server. A variety of authentication options are available, including scanning with an ID card. To ensure a secure scanning environment, different preset settings can be registered on each user's panel display to prevent misuse of the product. When the authentication setting is enabled on the product, user authentication is required in order to start scanning.

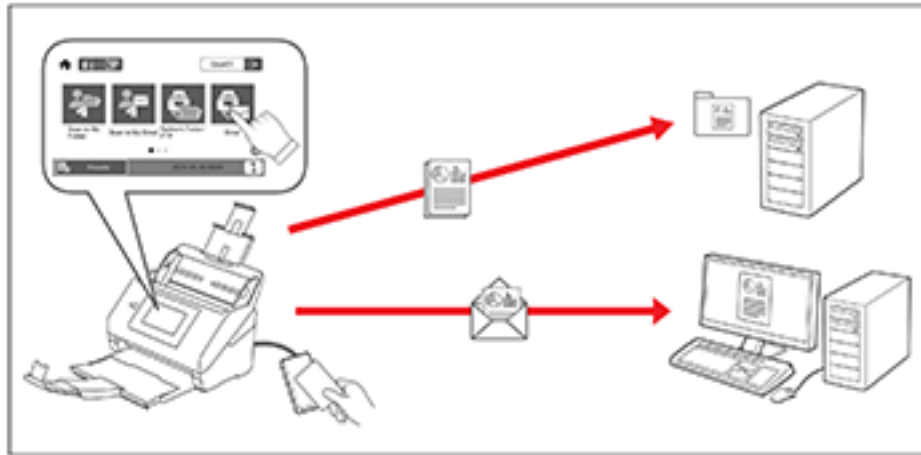

**Note:** You cannot scan from a computer or smart device when using authentication.

The following scanning options are available when authentication is enabled on your product. Some options may be restricted by your administrator. For more information, contact your administrator.

- **Scan to My Email** sends the scanned file to the authenticated user's email address.
- **Scan to My Folder** saves the scanned file to the folder assigned to the authenticated user.
- **Network Folder/FTP** saves the scanned file to a pre-defined folder on a network computer or FTP server.
- **Email** sends the scanned file directly from the product through a pre-defined email server.

- **Cloud** sends the scanned file directly from the product to a destination that you have registered with Epson Connect.
- **USB Drive** saves the scanned file directly to a USB device connected to the product. (This option is not available if an authentication device is connected to the product.)

**Note:** For detailed information about enabling authentication on your product, see the online [Administrator's Guide](#).

**Parent topic:** [Starting a Scan](#)

---

# Cleaning and Transporting Your Product

See these sections if you need to clean or transport your product.

[Cleaning Your Product](#)

[Cleaning Inside Your Product](#)

[Checking the Roller Counter](#)

[Replacing the Rollers](#)

[Transporting Your Product](#)

## Cleaning Your Product

To keep your product working at its best, you should clean it several times a year.

**Caution:** Do not use a hard brush, alcohol, or paint thinner to clean the product or you may damage it. Do not use oil or other lubricants inside the product or let water get inside it. Do not open the product's outer case.

1. Turn off the scanner and unplug the AC adapter.
2. Disconnect any connected cables.
3. Clean the outer case with a soft, dry cloth. Do not use liquid or chemical cleansers.

**Note:** If the outer case still requires additional cleaning, use a slightly damp cloth to wipe the outer case. Then wipe the case with a soft, dry cloth.

4. Clean the LCD screen with a soft, dry cloth.

**Parent topic:** [Cleaning and Transporting Your Product](#)

## Cleaning Inside Your Product

Clean your product regularly to make sure that no dust builds up on the glass scanning surfaces. Dust can cause spots or lines in your scanned images. Clean the inside of the product every 5,000 scans. You can check the latest number of scans using the Epson Scan 2 Utility.

**Caution:** Do not use a hard brush, alcohol, or paint thinner to clean the product or you may damage it. Do not use oil or other lubricants inside the product or let water get inside it. Do not open the product's outer case.

1. Turn off the product and unplug the AC adapter.
2. Disconnect any connected cables.
3. Pull down on the cover open lever and open the scanner cover.

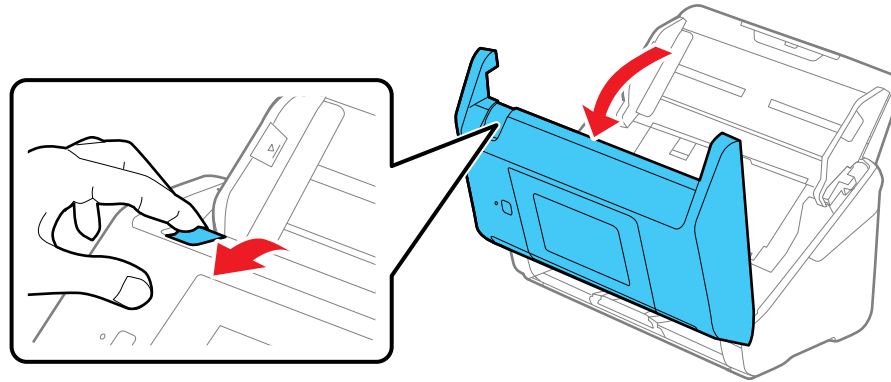

4. Use a genuine Epson cleaning kit or a soft cloth to wipe off any dust or dirt on the glass scanning surfaces and the rollers inside the scanner cover. If the glass surface is stained with grease or some other hard-to-remove material, use a genuine Epson cleaning kit to remove stains. Use a small amount of cleaner on the cleaning cloth to remove the stains. Wipe off all remaining liquid.

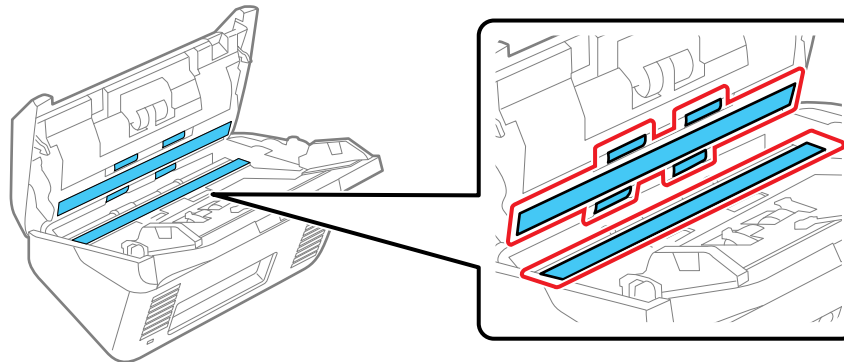

**Caution:** Do not spray glass cleaner directly on the scanning surfaces. Be careful not to place too much force on the glass.

5. Use a cotton swab to wipe off any dust or dirt on the sensors shown here.

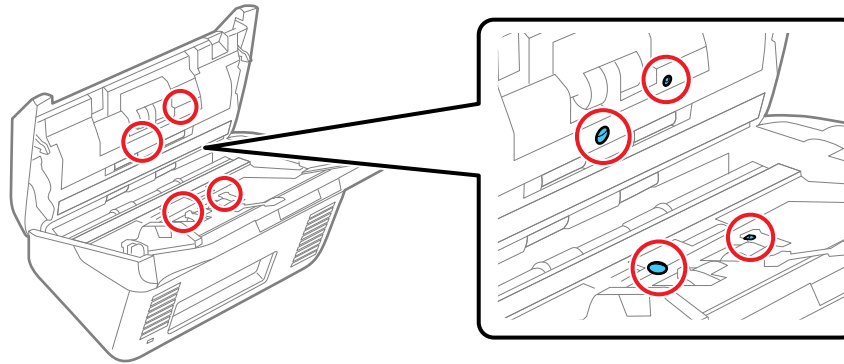

**Caution:** Do not use liquid or glass cleaner on the cotton swab.

6. Locate the separation roller.

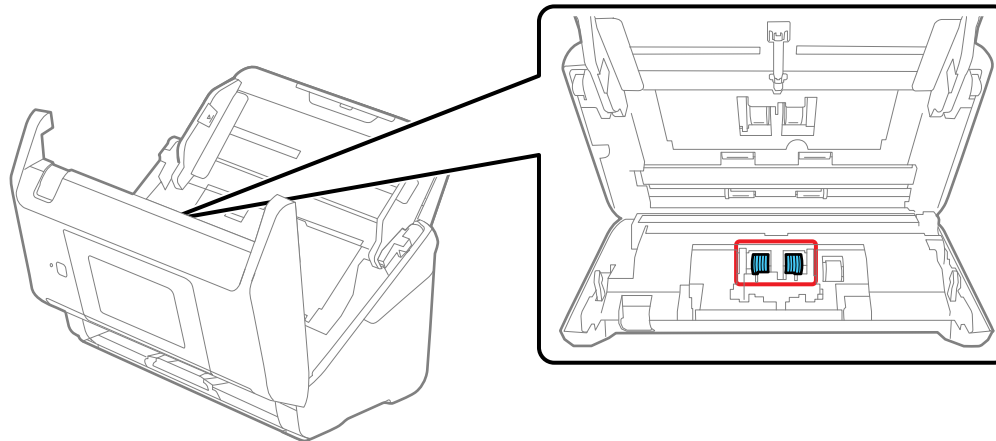



7. Squeeze the tabs on the sides of the separation roller cover and open the cover.

**Caution:** Be careful not to apply too much force when opening the cover.

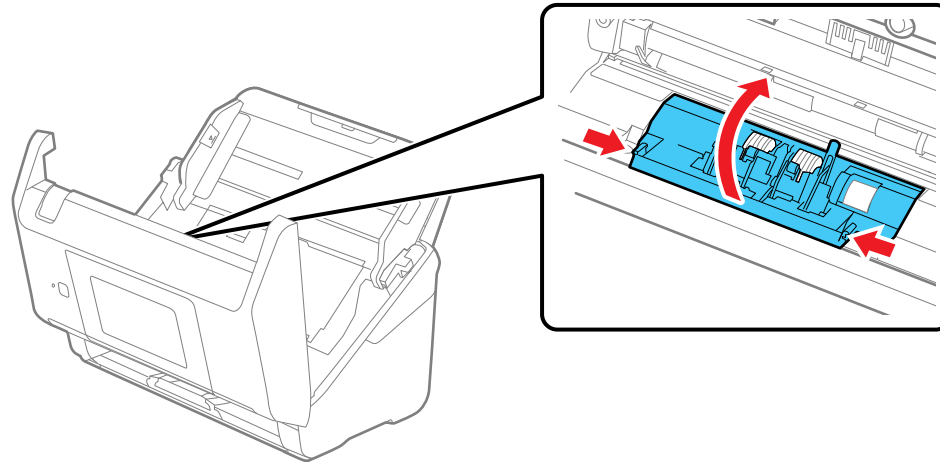

8. Slide the separation roller to the left and remove it.

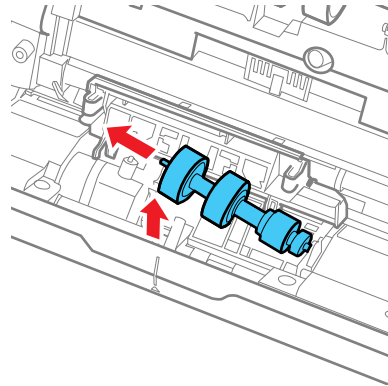

9. Wipe off any dust or dirt on the separation roller using a genuine Epson cleaning kit or a soft, moist cloth.

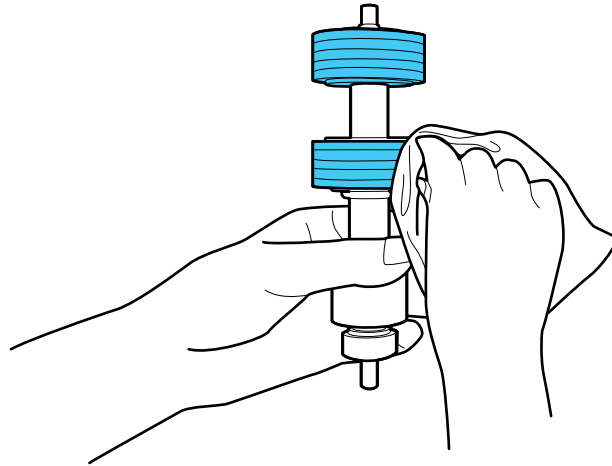

**Caution:** Use only a genuine Epson cleaning kit or soft, moist cloth to clean the roller; using a dry cloth may damage the surface of the roller. Do not spray cleaners directly inside the product; always spray cleaners on a cleaning cloth to slightly dampen the cloth. Wipe off any excess cleaner with a dry, lint-free cloth.

10. To replace the separation roller, insert the end of the roller into the hole on the right side and lower the other end of the roller into place.

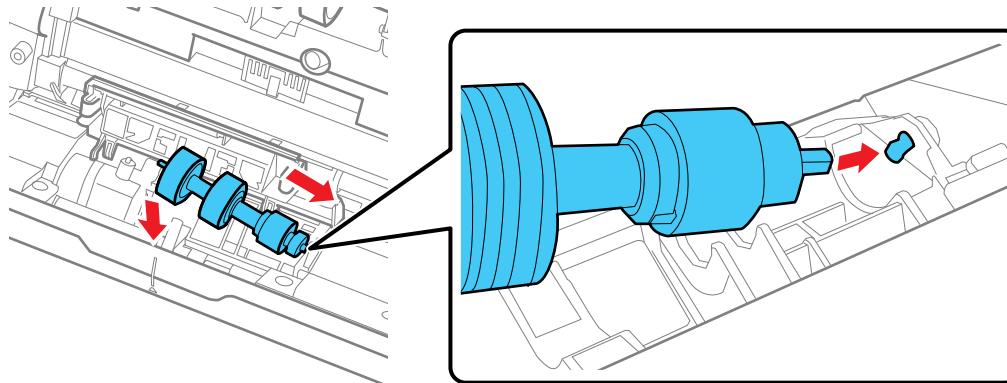

11. Close the separation roller cover until you hear it click into place.

**Note:** If you are not able to close the cover, the roller is not installed correctly. Remove the roller and reinstall it, then try to close the cover again.

12. Locate the pickup roller.

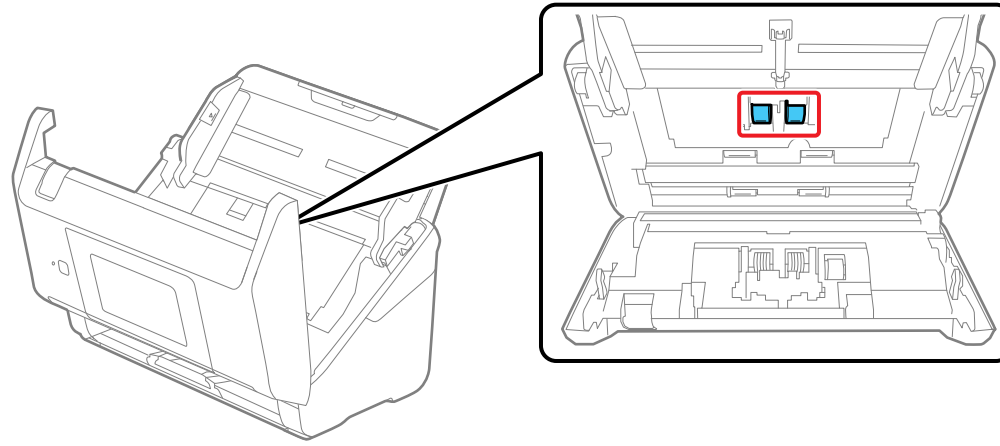

13. Press down on the pickup roller cover latch and pull up the cover to remove it.

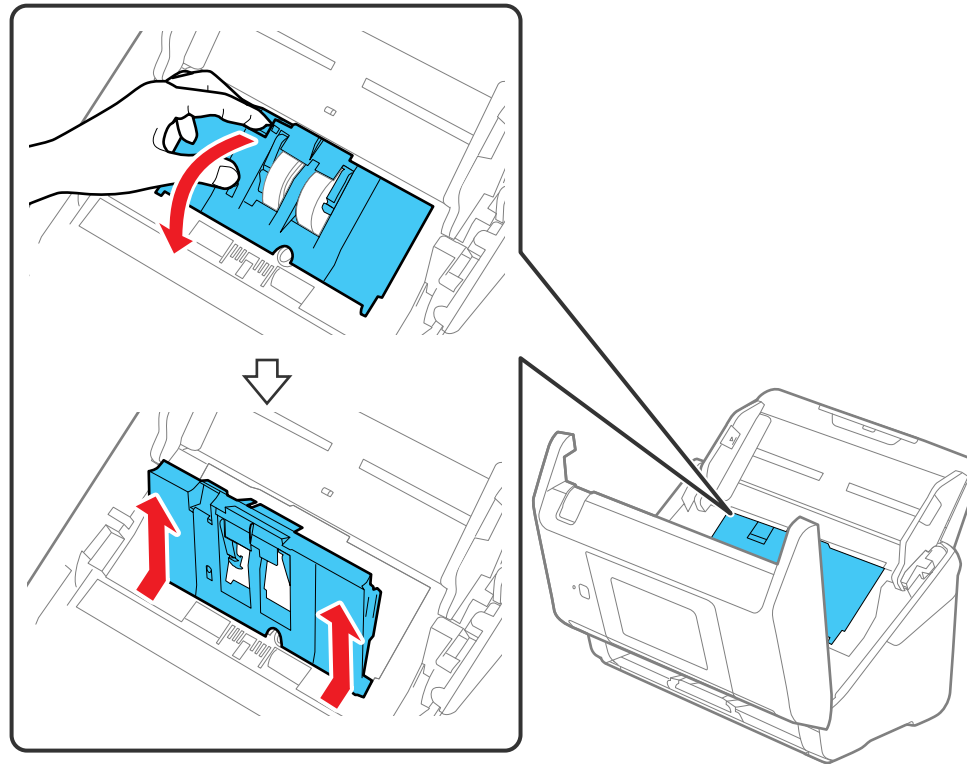

14. Pull down the tab on the pickup roller and slide the roller to the right to remove it.

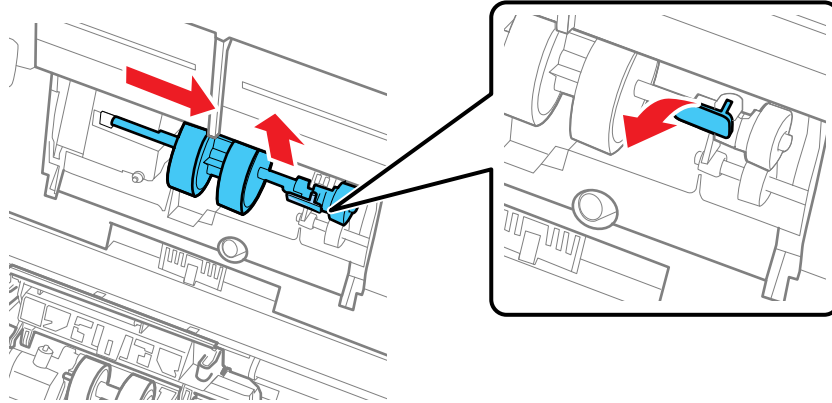

**Note:** Do not use force to pull out the pickup roller; doing so may damage the inside of the product.

15. Wipe off any dust or dirt on the pickup roller using a genuine Epson cleaning kit or a soft, moist cloth.

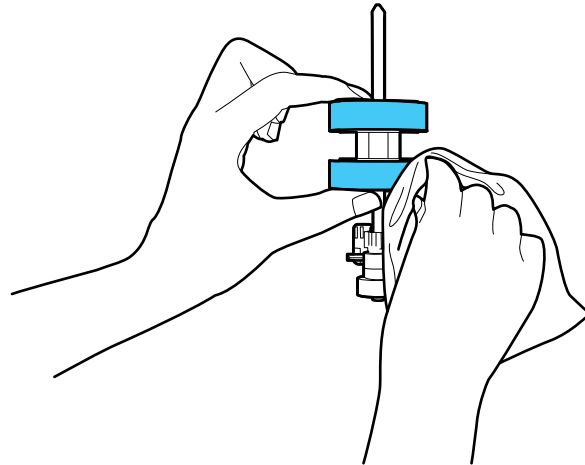

**Caution:** Use only a genuine Epson cleaning kit or soft, moist cloth to clean the roller; using a dry cloth may damage the surface of the roller.

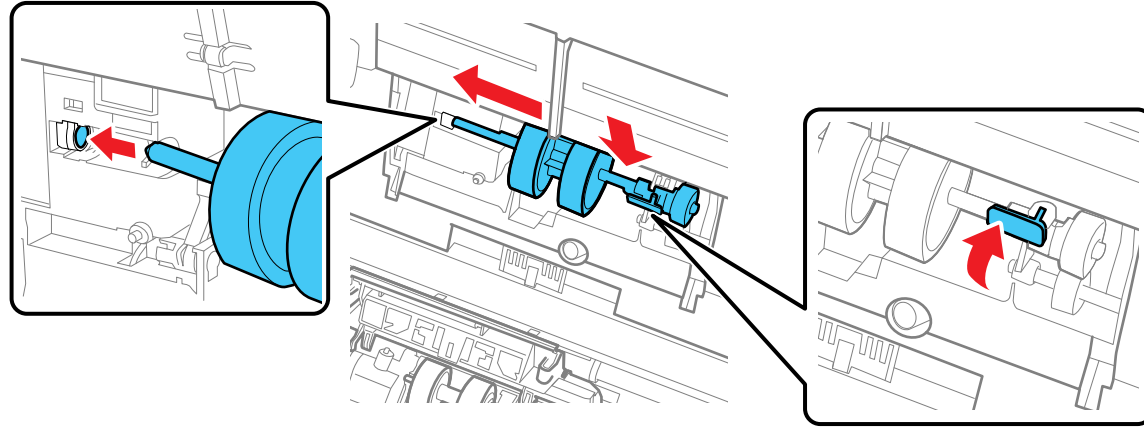

16. To replace the pickup roller, align the notches on the roller unit and slide it to the left. Press up on the tab to secure the roller.

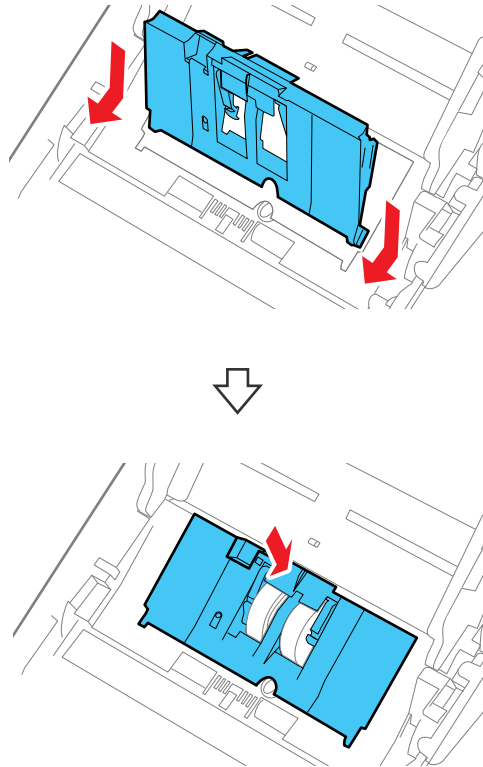

17. Align the bottom edge of the pickup roller cover into the notches as shown and press it down until it clicks into place.



**Note:** If you are not able to close the cover, the roller is not installed correctly. Remove the roller unit and reinstall it, then try to close the cover again.

18. Close the scanner cover.
19. Plug in the AC adapter and press the  power button to turn on the product.
20. Select the  home icon, if necessary, and select **Scanner Maintenance**.
21. Select **Roller Cleaning**.

22. Pull down on the cover open lever and open the scanner cover.

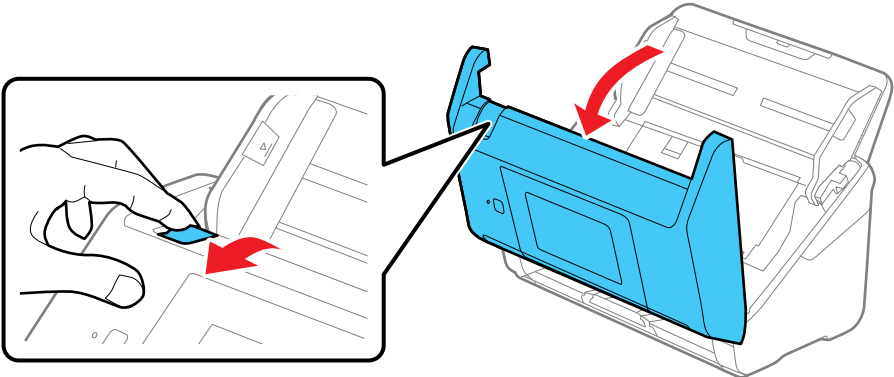

The product enters roller cleaning mode.



23. Slowly rotate the rollers shown here by tapping anywhere on the LCD screen. Use a genuine Epson cleaning kit or a soft, moist cloth to wipe off any dust or dirt on the rollers as they rotate. Repeat this step until the rollers are clean.

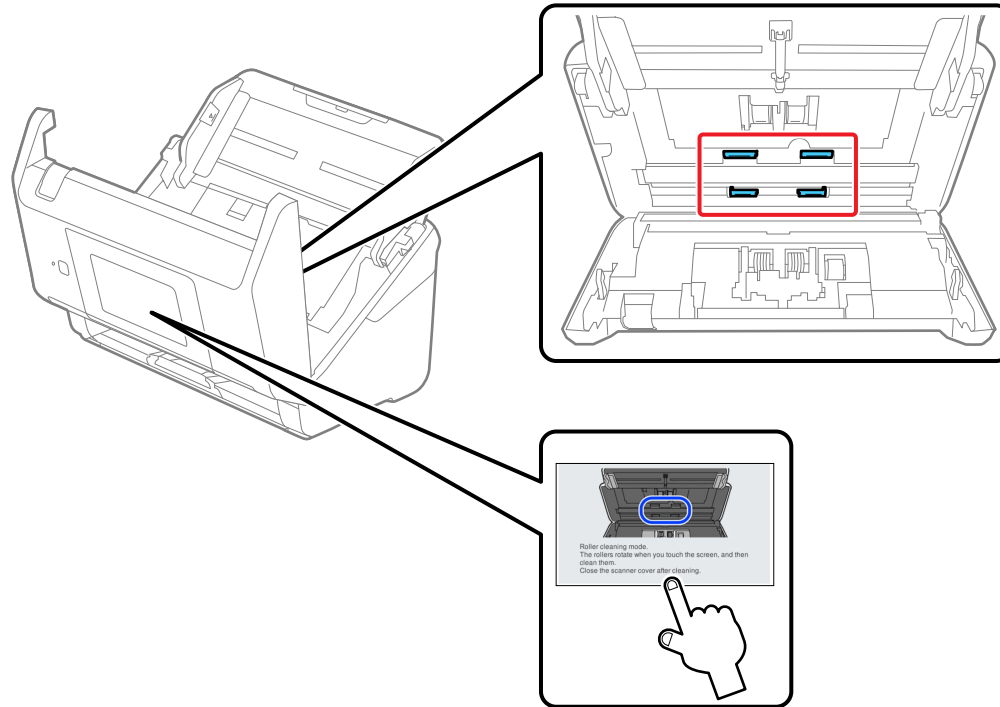

**Caution:** Be careful not to get your hands or hair caught in the rollers as they rotate.

24. Close the scanner cover.

The product automatically exits roller cleaning mode.

**Parent topic:** [Cleaning and Transporting Your Product](#)



**Related references**

[User Replaceable Epson Product Parts](#)

## Checking the Roller Counter

Check the product's roller counter to determine when your rollers need to be replaced. When you replace the rollers, reset the roller counter so you know when you may need to replace the rollers again.

**Note:** To check the roller counter from the product's control panel, select the  home icon, if necessary, and select **Scanner Maintenance > Roller Replacement**.

1. Make sure the product is turned on and connected to your computer.
2. Do one of the following to open the Epson Scan 2 Utility:
  - **Windows 11:** Click , then search for **Epson Scan 2 Utility** and select it.
  - **Windows 10:** Click  and select **EPSON > Epson Scan 2 Utility**.
  - **Windows 8.x:** Navigate to the **Apps** screen and select **Epson Scan 2 Utility**.
  - **Windows 7:** Click  > **All Programs > EPSON > Epson Scan 2 Utility**.
  - **Mac:** Open the **Applications** folder, click **Epson Software**, and click **Epson Scan 2 Utility**.
3. Click the **Counter** tab.

You see a screen like this:

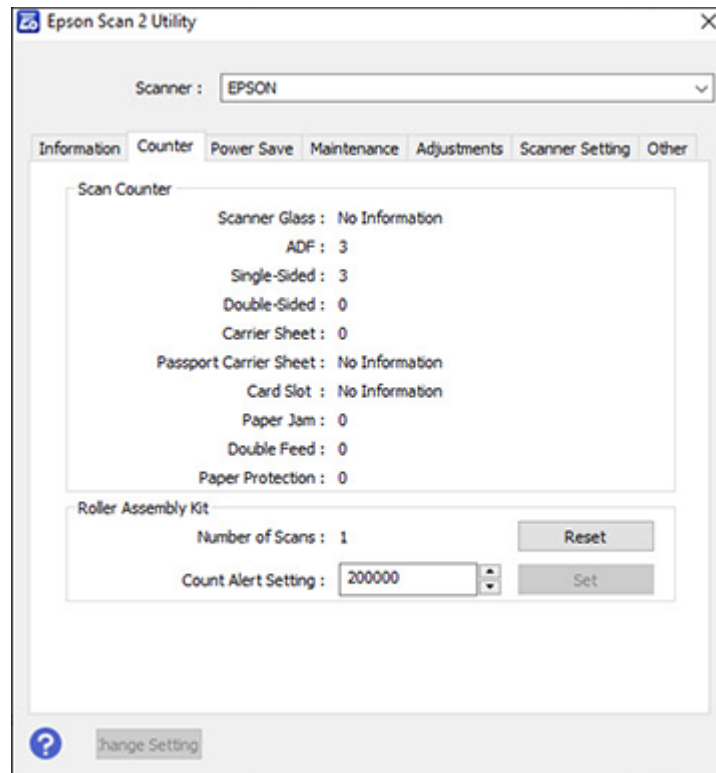

4. If the number in the **Number of Scans** field exceeds the life cycle of the rollers, it is time to replace the rollers.

**Note:** In the above screen, the life cycle of the rollers is the default number displayed in the **Count Alert Setting** field. The life cycle may vary depending on the paper type.

5. Close the Epson Scan 2 Utility.

**Parent topic:** [Cleaning and Transporting Your Product](#)

**Related tasks**

[Changing Roller Replacement Alert Settings](#)

## Replacing the Rollers

Replace the product's rollers when the number of scans exceeds the life cycle of the rollers. Check the roller counter to see when you need to replace the rollers.

**Note:** Frequent use of textured media may cause premature wear on the rollers. If frequent paper jams occur before the life cycle of the rollers is exceeded, try cleaning the rollers. In some cases, the rollers may need to be replaced before the number of scans exceeds the life cycle of the rollers.

1. Turn off the product.
2. Unplug the AC adapter.
3. Disconnect any connected cables.
4. Pull down on the cover open lever and open the scanner cover.

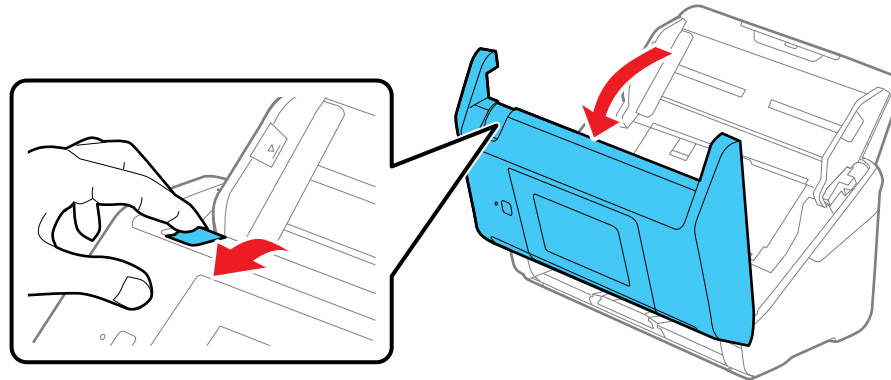

5. Press down on the pickup roller cover latch and pull up the cover to remove it.

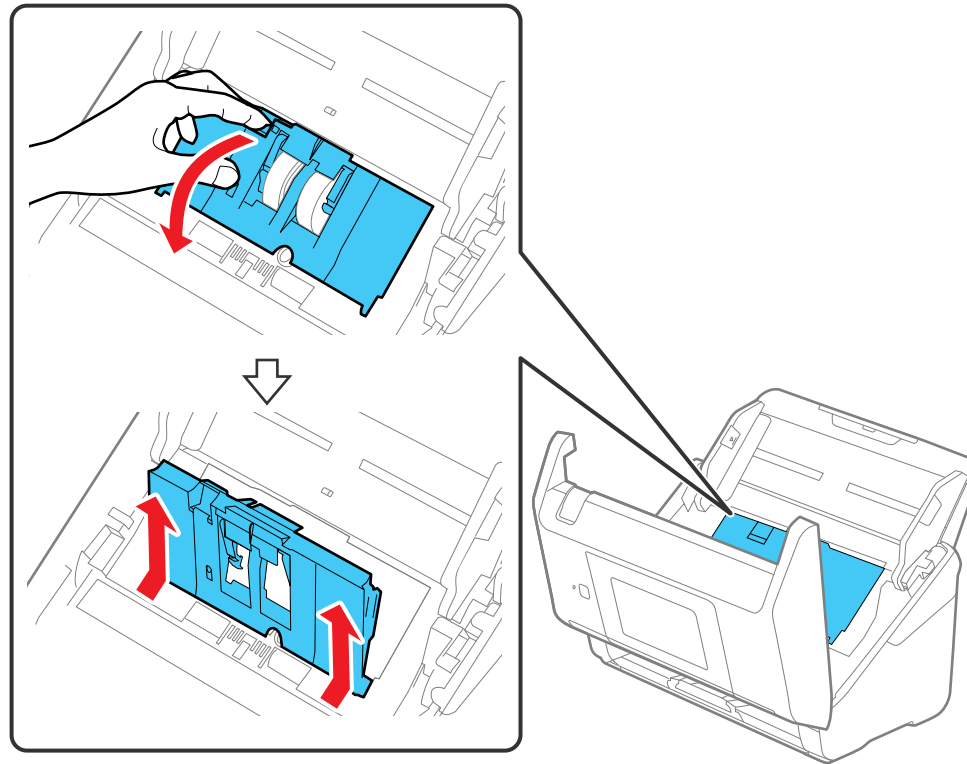

6. Pull down the tab on the pickup roller and slide the roller to the right to remove it.

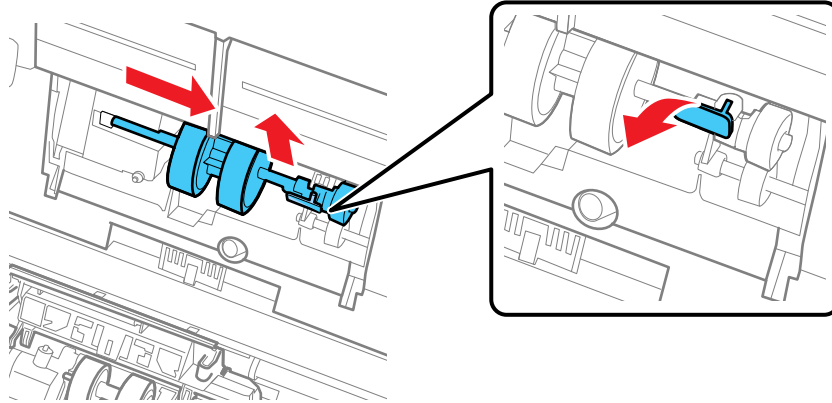

**Note:** Do not use force to pull out the pickup roller; doing so may damage the inside of the product.

7. To install the new pickup roller, align the notches on the roller unit and slide it to the left. Press up on the tab to secure the roller.

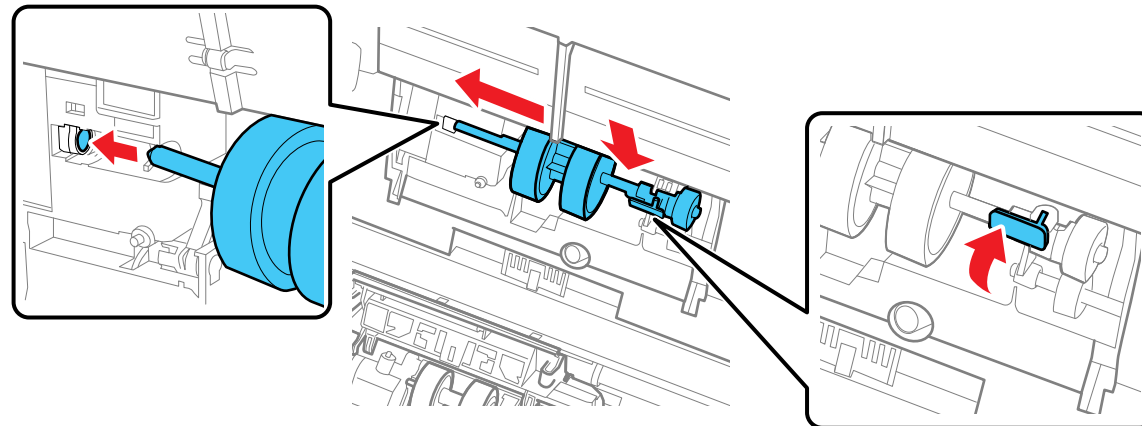

8. Align the bottom edge of the pickup roller cover into the notches as shown and press it down until it clicks into place.

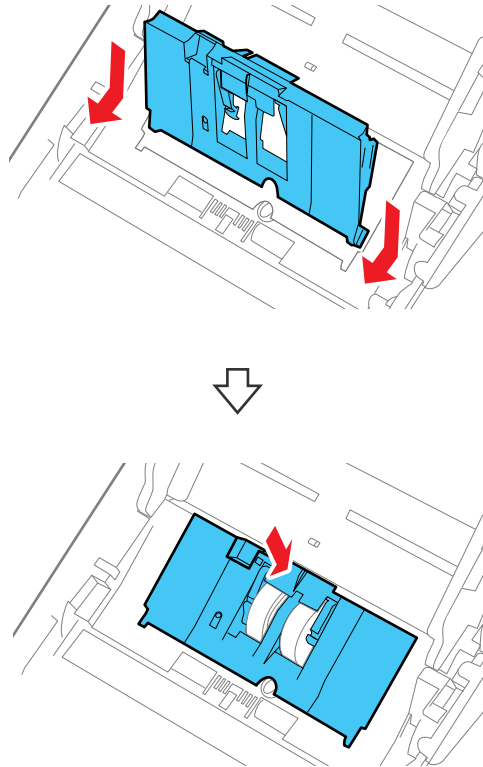

**Note:** If you are not able to close the cover, the pickup roller is not installed correctly. Remove the roller unit and reinstall it, then try to close the cover again.

9. Squeeze the tabs on the sides of the separation roller cover and open the cover.

**Caution:** Be careful not to apply too much force when opening the cover.

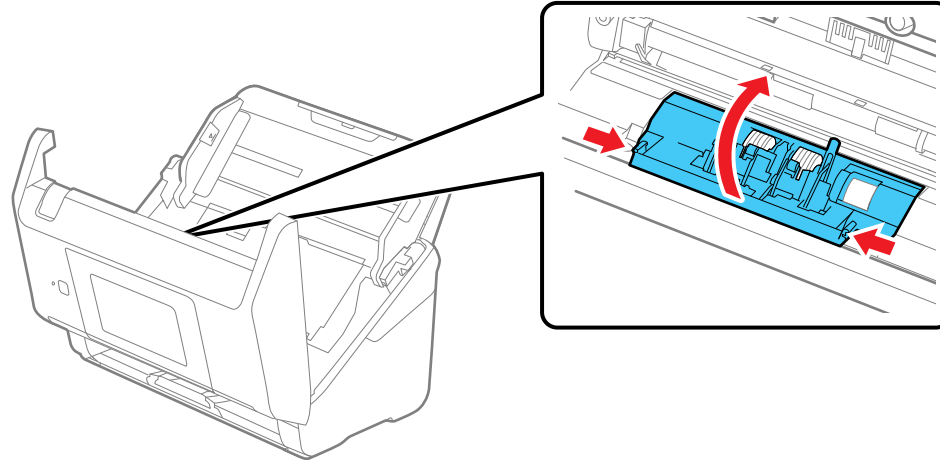

10. Slide the separation roller to the left and remove it.

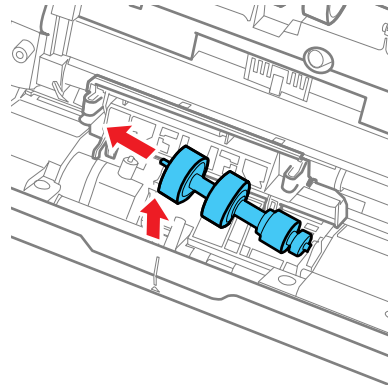



11. To install a new separation roller, insert the end of the roller into the hole on the right side and lower the other end of the roller into place.

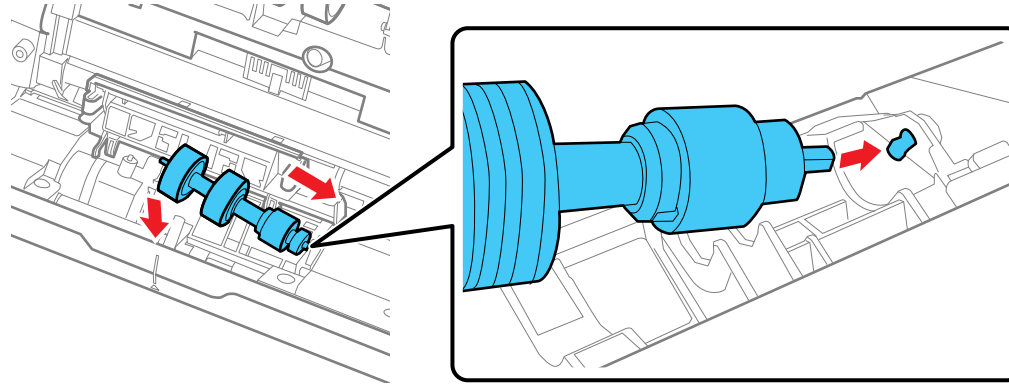

12. Close the separation roller cover until you hear it click into place.

**Note:** If you are not able to close the cover, the roller is not installed correctly. Remove the roller and reinstall it, then try to close the cover again.

13. Close the scanner cover.
14. Connect any disconnected cables.
15. Plug in the AC adapter and turn on the product.
16. Reset the roller counter.

**Note:** Make sure to dispose of the pickup roller and the separation roller following the rules and regulations of your local authority. Do not disassemble them.

#### [Resetting the Roller Counter](#)

**Parent topic:** [Cleaning and Transporting Your Product](#)

#### **Related references**

[User Replaceable Epson Product Parts](#)

#### **Related tasks**

[Checking the Roller Counter](#)

[Changing Roller Replacement Alert Settings](#)

## Resetting the Roller Counter

When you replace the product's rollers, reset the roller counter so you know when you may need to replace the rollers again.

1. Select the  home icon, if necessary.
2. Do one of the following:
  - Select **Scanner Maintenance > Roller Replacement > Reset the Number of Scans > Number of Scans After Replacing Roller > Yes.**
  - Select **Settings > Device Information > Reset the Number of Scans > Number of Scans After Replacing Roller > Yes.**

**Note:** You can also reset the roller counter from your computer using the Epson Scan 2 Utility. Select the **Counter** tab and click **Reset**.

**Parent topic:** [Replacing the Rollers](#)

### Related tasks

[Checking the Roller Counter](#)

[Changing Roller Replacement Alert Settings](#)

## Transporting Your Product

If you need to ship your product, transport it a long distance, or store it for an extended period, prepare it for transportation as described here.

1. Turn off the product and unplug the AC adapter.
2. Disconnect any connected cables.

3. Close the input tray extension and the output tray.

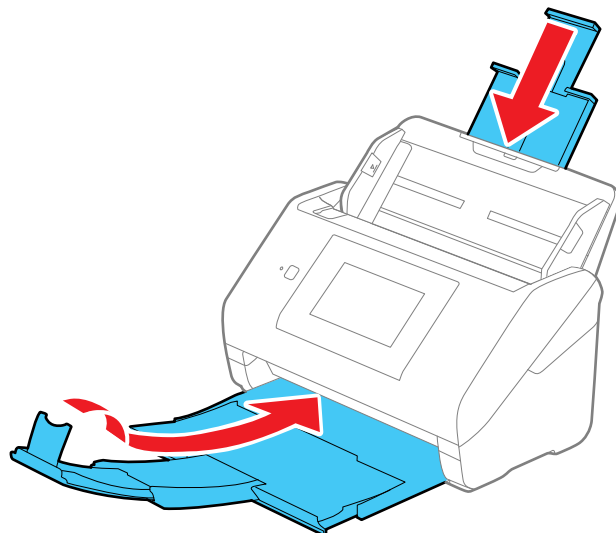

**Note:** Make sure the output tray is securely closed.

4. Push apart the latches on the back on the input tray and lift the input tray off of the product.

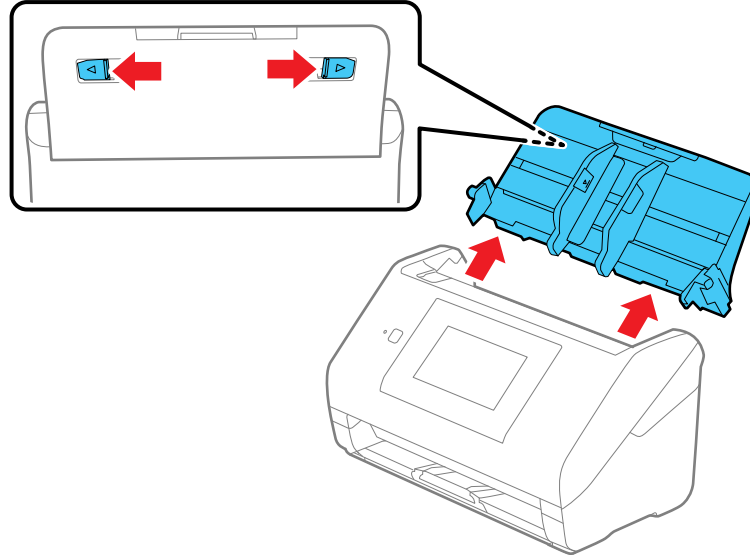

5. Place the product in its original packing materials, if possible, or use equivalent materials with cushioning around the product.

**Parent topic:** [Cleaning and Transporting Your Product](#)

---

# Solving Problems

Check these sections for solutions to problems you may have using your product.

[Product Status Messages](#)

[Solving Scanning Problems](#)

[Solving Network Scanning Problems](#)

[Solving Scanned Image Quality Problems](#)

[Resetting the Epson Scan 2 Settings](#)

[Uninstall Your Product Software](#)

[Where to Get Help \(U.S. and Canada\)](#)

[Where to Get Help \(Latin America\)](#)

## Product Status Messages

You can often diagnose problems with your product by checking the messages on its LCD screen. You can also select the ⓘ help icon to see help information and how-to instructions on the screen.

**Note:** If the LCD screen is dark, tap the screen to wake the product from sleep mode.

LCD screen message	Condition/solution
Check the following if a computer is not found. - Connection between the scanner and the computer (USB or network) - Installation of a necessary application - Application version - Power supply to the computer - Firewall and security software settings - Group settings of a scanner and Document Capture Pro - Execution of re-searching For details, see your documentation.	Try the following: <ul style="list-style-type: none"><li>• Make sure the product is connected correctly and the latest versions of Epson Scan 2 and Document Capture Pro (Windows) or Document Capture (Mac) are installed on your computer.</li><li>• Make sure the AC adapter is securely connected to the product and an electrical outlet. Check that the outlet is working properly by plugging another electrical device into it.</li><li>• Check the firewall settings for Epson software.</li><li>• Make sure the Group setting is the same for the computer and the product.</li><li>• Search for the computer again.</li></ul>

LCD screen message	Condition/solution
The combination of the IP address and the subnet mask is invalid. See your documentation for more details.	There is a problem with the network connection to your product. Check the solutions in this guide.
RECOVERY MODE	A firmware update has failed. Connect your product using a USB cable and try updating the firmware again. If you still receive this error message, contact Epson for support.
DNS error. Check DNS settings.	<p>A communication error during scanning to a shared folder over a network has occurred. Try the following:</p> <ul style="list-style-type: none"> <li>• Make sure the computer you are scanning to is turned on and not in sleep mode.</li> <li>• Temporarily disable the computer's firewall and security software, then try saving a scan over the network again. If successful, check your security software settings.</li> <li>• Check the computer's network type to make sure it is not set to Public; you cannot save a scan to a shared folder over a public network. Click the link to "Cannot Save a Scan to a Shared Folder Over a Network" below for instructions.</li> <li>• Make sure the shared folder path matches the path registered to your product contacts list.</li> <li>• Make sure the IP address of the computer is correct. If using DHCP, obtain the IP address again. If using a static IP address, change the computer name in the shared folder path to the IP address and try again. (For example, change \\EPSON02\SCAN to \\192.168.xxx.xxx\SCAN)</li> <li>• Make sure the DNS setting is correct, and that the computer name and IP address match when the DNS server management table is updated. Contact your network administrator.</li> </ul>
Authentication error. Check the location, user name and password.	An authentication error during scanning to a shared folder over a network has occurred. Make sure the computer's user name and password are correct and match those registered to your product contacts list. Also make sure the password has not expired.

LCD screen message	Condition/solution
Communication error. Check the Wi-Fi/network connection.	<p>A wireless communication error during scanning to a shared folder over a network has occurred. Try the following:</p> <ul style="list-style-type: none"> <li>• Make sure the path to the shared folder matches the path registered to your product's contact list.</li> <li>• Make sure you enabled access rights to the shared folder in the folder Properties when you created the shared folder. See the link below for instructions on creating a shared folder using the correct properties.</li> <li>• Windows: Make sure the <b>Use Microsoft network sharing</b> setting is enabled in Web Config. Select <b>Network &gt; MS Network</b> to access the setting. See the link below for instructions on accessing Web Config.</li> </ul>
The file name is already in use. Rename the file and scan again.	A file of the same name already exists in the shared network folder you are trying to scan to. Change the file name, or move or deleted files as necessary and try scanning to the shared folder again.
Scanned file(s) are too large. Only XX page(s) have been sent. Check if the destination has enough space.	The storage on the computer you are trying to scan to does not have enough space to store your scan. Increase the free space and try again.

**Parent topic:** [Solving Problems](#)

**Related references**

[Where to Get Help \(U.S. and Canada\)](#)

[Where to Get Help \(Latin America\)](#)

**Related tasks**

[Replacing the Rollers](#)

[Setting a Password and Locking the Control Panel](#)

[Changing Regular Cleaning Alert Settings](#)

[Changing Roller Replacement Alert Settings](#)

[Cleaning Inside Your Product](#)

[Accessing the Web Config Utility](#)

[Creating a Shared Network Folder](#)

## Related topics

[Loading Originals](#)

# Solving Scanning Problems

Check these solutions if you have problems scanning with your product.

[Product Does Not Turn On or Turns Off Unexpectedly](#)

[Forgot the Administrator Password](#)

[Scanner Button Does Not Work as Expected](#)

[Scanning Software Does Not Operate Correctly](#)

[Paper Feeding Problems](#)

[Paper Jam Problems](#)

[Paper Protection Does Not Work Correctly](#)

[Scanning is Slow](#)

[Cannot Send Scans to a Cloud Service](#)

[Cannot Send Scans to an Email](#)

**Parent topic:** [Solving Problems](#)

## Product Does Not Turn On or Turns Off Unexpectedly

If the product does not turn on or if it turns off unexpectedly, try these solutions:

- Make sure the AC adapter is securely connected to the product and to a working electrical outlet.
- If the product turns off unexpectedly, you may need to adjust the **Sleep Timer** and **Power Off Timer** settings on the control panel.

**Parent topic:** [Solving Scanning Problems](#)

### Related tasks

[Changing the Sleep Timer Settings](#)

[Changing the Power Off Timer Settings](#)

## Forgot the Administrator Password

If you forget the password or inadvertently set it, contact Epson for assistance.

**Note:** In most cases, the default password is the product's serial number. If there is a "Password" label attached to the back of the product, enter the 8-digit number shown on the label. If there is no "Password" label attached, enter the serial number on the label attached to the base of the product for



the initial administrator password. If you restore the product to default settings, the administrator password resets to the product serial number.

**Parent topic:** [Solving Scanning Problems](#)

**Related tasks**

[Setting a Password and Locking the Control Panel](#)

## Scanner Button Does Not Work as Expected

If the scanner button does not start the correct program or perform the correct action, try these solutions:

- Make sure your scanner is turned on and any interface cables are securely connected at both ends.
- Check the USB cable connection between the computer and scanner if you are connecting via USB.
- Check that the correct scanner is selected using the Epson Scan 2 Utility.
- In Windows, be sure that the scanner is listed under **Imaging Devices** in the Device Manager.
- Make sure Document Capture Pro (Windows) or Document Capture (Mac) is installed correctly. If necessary, uninstall and reinstall it.
- Make sure you have assigned the correct job to the scanner button and change it, if necessary.
- Check the status of the lights and make sure the scanner is ready to scan.
- If you are connecting your scanner over a network, make sure the Wi-Fi connection is working correctly. Try turning the wireless router off and on again, and make sure the router cable is securely connected.
- If you are connecting your scanner via USB, use only the USB cable that came with the scanner. Make sure it is connected directly to your computer and not to a USB hub.
- Make sure your scanner is not connected to another computer via USB. A USB connection takes priority over a Wi-Fi connection.
- Make sure Epson Scan 2 and other applications are installed correctly. If necessary, uninstall and reinstall it.

**Parent topic:** [Solving Scanning Problems](#)

## Scanning Software Does Not Operate Correctly

If your scanning software does not operate correctly, try these solutions:

- Make sure your computer has adequate memory and meets the system requirements for your operating system.

- Make sure your computer is not running in a power-saving mode, such as sleep or standby. If so, wake your system and restart your scanning software.
- Make sure the product is turned on.
- Make sure the scanning software is installed.
- Make sure the connection between the product and your computer is secure.
- If you upgraded your operating system but did not reinstall your scanning software, try reinstalling it.
- In Windows, be sure that the product is listed under **Imaging Devices** in the Device Manager.
- Check that the correct product is selected using the Epson Scan 2 Utility.
- Check that the correct setting is assigned to the scanner button in Document Capture Pro (Windows) or Document Capture (Mac).
- Connect the product directly to the computer. The product may not work properly when connected through a USB hub/switch.
- Plug the USB Type A connector into a USB 3.0 port on your computer, if available.
- Document Capture Pro (Windows) does not support Windows Vista or Windows Server, so use Epson Scan 2 for scanning instead.
- If you are using a TWAIN-compliant program, make sure that the correct product is selected as the **Scanner** or **Source** setting.
- Make sure the **PC Connection via USB** setting is not disabled on the control panel.
- Check that the Wi-Fi connection is working correctly. Try turning the wireless router off and on.
- If you are using the product over a network, make sure the network cable is securely connected.
- Make sure another computer is not connected to the product using a USB cable. A USB connection takes priority over a Wi-Fi connection. If another computer is connected by USB, disconnect it.
- If you are using a Mac computer, make sure you select the network that has priority on it.

**Parent topic:** [Solving Scanning Problems](#)

**Related concepts**

[Uninstall Your Product Software](#)

**Related references**

[Windows System Requirements](#)

[Mac System Requirements](#)

## Paper Feeding Problems

If you have problems feeding originals in your product, try these solutions:

- If multiple pages feed at once, try the following:
  - Remove the originals, fan the edges to separate the sheets, if necessary, and reload them.
  - Load fewer originals at a time.
  - Load only originals that meet the specifications for your product.
  - Clean inside the product and replace the roller assembly kit, if necessary.
  - Check the pickup rollers and clean, if necessary.
  - Select  on the product control panel to slow down the scanning speed.
  - Use **Automatic Feeding Mode** in Epson Scan 2 and scan originals one at a time.
  - Use the optional carrier sheet for thin, folded, or irregularly shaped originals.
- If you see a double feed error in the Epson Scan 2 window or the Document Capture Pro window, start Epson Scan 2, select the **Main Settings** tab, select the **Detect Double Feed** setting, and select **Off**.

**Parent topic:** [Solving Scanning Problems](#)

### Related references

[Original Document Specifications](#)

[Plastic and Laminated Card Specifications](#)

[Special Original Specifications](#)

[User Replaceable Epson Product Parts](#)

### Related tasks

[Cleaning Inside Your Product](#)

### Related topics

[Loading Originals](#)

## Paper Jam Problems

If an original has jammed inside the product, follow these steps:

**Note:** Epson Smart Panel does not support scanning originals more than 15.5 inches (398.3 mm) in length.

1. Turn off your product.

2. Remove all originals from the input tray.
3. Pull down the cover open lever and open the scanner cover.

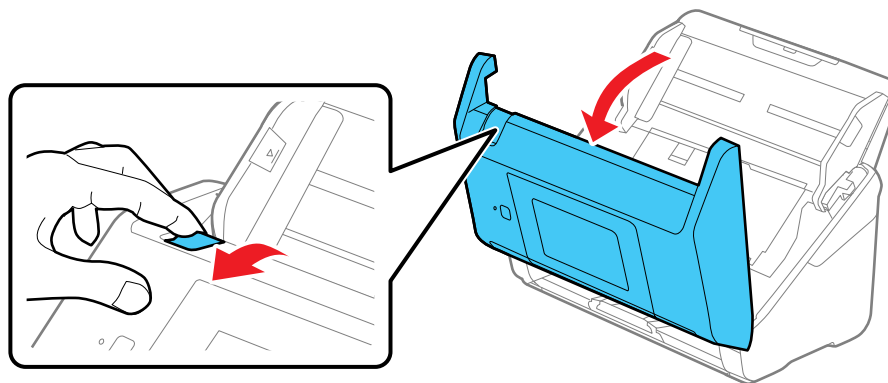

4. Gently pull out any jammed originals from inside the product.

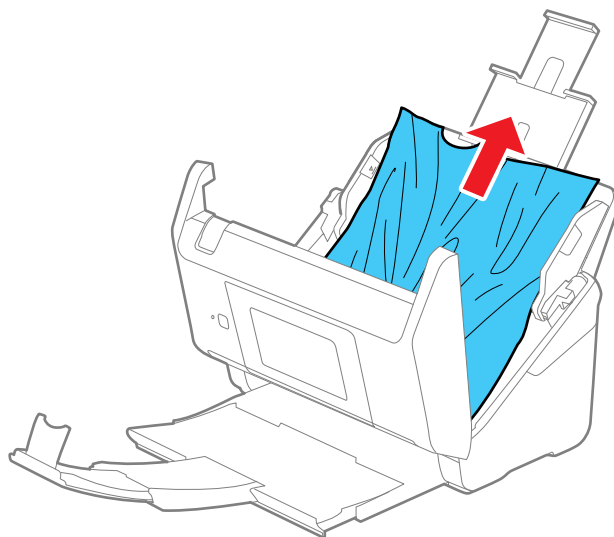

5. Gently pull out any jammed originals from the output tray.

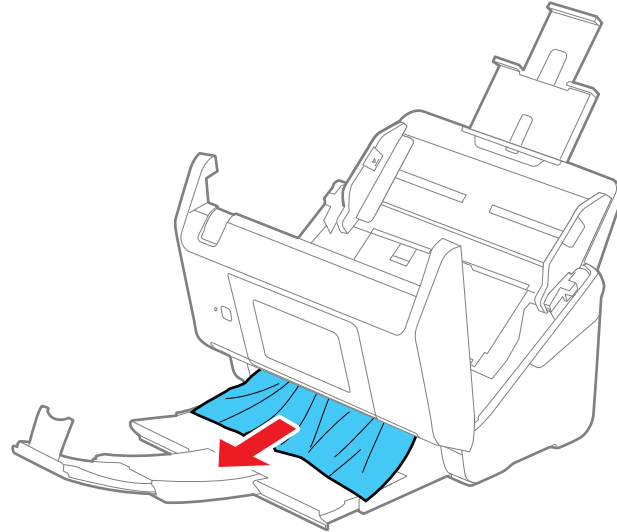

6. Close the scanner cover.

7. Carefully follow all loading instructions when you reload originals.

If originals jam in the product frequently, try the following:

- Select  on the product control panel to slow down the scanning speed.
- Turn off the **Detect Double Feed** setting.
- Clean inside the product and clean the rollers.
- Close the output tray and let the originals fall freely onto the surface below the scanner.
- If the roller counter is nearing end of life, replace the roller assembly kit.

**Parent topic:** [Solving Scanning Problems](#)

**Related references**

[Original Document Specifications](#)

[Plastic and Laminated Card Specifications](#)

[Special Original Specifications](#)

[Where to Get Help \(U.S. and Canada\)](#)

[Where to Get Help \(Latin America\)](#)

### Related tasks

[Cleaning Inside Your Product](#)

### Related topics

[Loading Originals](#)

## Paper Protection Does Not Work Correctly

To reduce damage to the original, the Paper Protection feature immediately stops scanning if a paper feed error is detected. If the Paper Protection feature does not work correctly, try these solutions:

- If your scanned original is damaged, make sure that the Paper Protection feature is enabled. Increase the detection level, if necessary.
- If misdetection occurs frequently, lower the Paper Protection detection level.
- Set the Paper Protection feature to **Off** on the LCD screen (**Settings > Scanner Settings > Paper Protection > Off**) when scanning plastic cards and thick originals.
- When scanning multiple originals, make sure that the leading edges of the documents are aligned. If the leading edges of the documents are not aligned, they may be mistakenly detected as a paper feed error even if they are scanned correctly.
- Make sure you align the edge guides with the original to avoid scanning at an angle.

Parent topic: [Solving Scanning Problems](#)

## Scanning is Slow

If scanning becomes slow, try these solutions:

- Scan your original at a lower resolution, if possible.
- Make sure your system meets the requirements for your operating system. If you are scanning a high-resolution image, you may need more than the minimum requirements. If necessary, increase your system's memory or reduce the resolution.
- The scanning speed may be reduced depending on the image adjustment features in Epson Scan 2.
- If scanning becomes slower after scanning continuously with the ADF for a long time, the scanner may have automatically slowed down to protect the scanner mechanism from overheating or becoming damaged. Let the scanner rest with the power on for 30 minutes, then try scanning again.
- Make sure the  slow mode setting is turned off on the scanner control panel.
- If you are running virus protection or other security software, exclude the TWAIN.log files from monitoring or set the TWAIN.log file as read only. See your virus protection or security software instructions for details. The TWAIN.log file is saved in C:\Users\*(user name)*\AppData\Local\Temp.

**Note:** You may need to unhide system folders to view files in that location.

- If you are scanning over a network, factors such as interference, network traffic, or weak signal strength may affect your scanning speed.
- Computers with USB 3.0 (SuperSpeed) or USB 2.0 (Hi-Speed) ports can scan faster than those with USB 1.1 ports. If you are using a USB 3.0 or 2.0 port with the scanner, make sure it meets the system requirements.

**Parent topic:** [Solving Scanning Problems](#)

**Related references**

[Windows System Requirements](#)

[Mac System Requirements](#)

## Cannot Send Scans to a Cloud Service

If you cannot send a scan to a cloud service, try these solutions:

- Make sure your computer is connected to the internet.
- Make sure the login information you entered for the cloud service is correct.
- Make sure the cloud service is not down for system maintenance. Check the cloud service website for more information.

**Parent topic:** [Solving Scanning Problems](#)

## Cannot Send Scans to an Email

If you cannot send a scan to an email address, try these solutions:

- Make sure the destination email address is working.
- Make the email server settings are correct.
- Contact the email server administrator to make sure the server is running.

**Parent topic:** [Solving Scanning Problems](#)

## Solving Network Scanning Problems

Check these solutions if you have problems scanning over a network.

[Product Cannot Connect to a Wireless Router or Access Point](#)

[Network Software Cannot Find Product on a Network](#)

[Wired Network Connection Becomes Unstable](#)

[Cannot Scan Over a Network](#)

[Cannot Save a Scan to a Shared Folder Over a Network](#)

**Parent topic:** [Solving Problems](#)

## **Product Cannot Connect to a Wireless Router or Access Point**

If your product has trouble finding or connecting to a wireless router or access point, try these solutions:

- If you are connecting the product via Wi-Fi Protected Setup (WPS), make sure you activate WPS on your product within 2 minutes of activating WPS discovery mode on the router by pressing the WPS button or enabling the WPS setting in your router firmware.
- Make sure to place your product within contact range of your router or access point. Avoid placing your product near a microwave oven, 2.4 GHz cordless phone, or large metal object, such as a filing cabinet.
- Verify that your router or access point is operating correctly by connecting to it from your computer or another device.
- You may need to temporarily disable your firewall and any anti-virus software on your wireless router or access point. Then try scanning again. You can also unblock your product driver or network address in your firewall or anti-virus software.
- Check to see if access restrictions, such as MAC address filtering, are set on the router or access point. If access restrictions are set, add your product's MAC address to your router's address list. To obtain your product's MAC address, check the label on the back or bottom of your product. Then follow the instructions in your router or access point documentation to add the address to the list.
- If your router or access point does not broadcast its network name (SSID), follow the instructions that came with your product to enter your wireless network name manually.
- If your router or access point has security enabled, determine the kind of security it is using and any required password or passphrase for connection. Then make sure to enter the exact WEP key or WPA passphrase correctly.
- Check if your computer is restricting the available wireless channels. If so, verify that your wireless access point is using one of the usable channels and change to a usable channel, if necessary.
- The product may not be able to communicate with a computer with both Ethernet and Wi-Fi adapters enabled. Disable all network interfaces except for the interface connected to the product.
- Turn off all of the devices you are trying to connect to the network. Wait about 10 seconds, and then turn on the devices in the following order; wireless router, computer or smart device, scanner. Move the scanner and computer or smart device closer to the wireless router, and then try to make network settings again.



- If you are using multiple wireless routers at the same time or the wireless router has multiple SSIDs and devices are connected to different SSIDs, you cannot connect to the wireless router. Connect the computer or smart device to the same SSID as the scanner.
- Enable the DHCP function on the router or access point.
- Check that the product's IP address is set correctly.
- If you cannot start scanning from a smart device, make sure the product and smart device are connected correctly. Use the Epson Smart Panel to check the connection status for the smart device and the product.

**Parent topic:** [Solving Network Scanning Problems](#)

**Related concepts**

[Wi-Fi Direct \(Simple AP\) Mode Setup](#)

**Related tasks**

[Selecting Wireless Network Settings from the Control Panel](#)

[Using the Epson Smart Panel Mobile App](#)

**Related topics**

[Wi-Fi or Wired Networking](#)

## Network Software Cannot Find Product on a Network

If EpsonNet Setup cannot find your product on a network, try these solutions:

- Make sure your product is turned on and connected to your network. Verify the connection using your product control panel.
- Check if your network name (SSID) contains non-ASCII characters. Your product cannot display non-ASCII characters.
- Make sure your product is not connected to a guest network.
- If necessary, reinstall your software and try running EpsonNet Setup again:
  1. Reset your product's network settings to their factory defaults.
  2. **Windows only:** Uninstall your product software.
  3. Restart your router following the instructions in your router documentation.

**Note:** If you are reading these instructions online, you will lose your Internet connection when you restart your router, so note the next step before restarting it.

4. Download your product software from the Epson website using the instructions on the *Start Here* sheet.
- If you have replaced your router, reinstall your product software to connect to the new router.
  - Check to see if your wireless router or access point has an enabled Privacy Separator function that is preventing detection of your device over the network. See your router or access point documentation for instructions on disabling the Privacy Separator function.

**Parent topic:** [Solving Network Scanning Problems](#)

**Related concepts**

[Uninstall Your Product Software](#)

[Wi-Fi Direct \(Simple AP\) Mode Setup](#)

## Wired Network Connection Becomes Unstable

When you connect your product to a wired network using a router or access point that supports IEEE 802.3az (Energy Efficient Ethernet), the connection may become unstable, you may be unable to connect to the product, and the communication speed may become slow. If you experience any of these issues, follow the steps below to disable IEEE 802.3az and then connect your product again.



1. Disconnect the Ethernet cables connected to the computer and your product.
2. Disable IEEE 802.3az for the computer's network adapter if it is enabled (check your operating system's Ethernet connection settings).
3. Connect the computer and your product directly with an Ethernet cable.
4. Check the product's IP address on the LCD screen (**Settings > Network Settings > Network Status > Wired LAN/Wi-Fi Status > IP Address**).
5. On the computer, open a web browser and enter your product's IP address.
6. Select **Network > Wired LAN**.
7. Select **OFF** for IEEE 802.3az. and click **Next**.
8. Click **OK** and remove the Ethernet cable connecting the computer and your product.
9. If you disabled IEEE 802.3az for your computer's network adapter, enable it.
10. Reconnect the Ethernet cables from the router or access point to your computer and product.

If problems still occur, other devices on the network may be causing them.

**Parent topic:** [Solving Network Scanning Problems](#)

## Cannot Scan Over a Network

If you have problems scanning over a network, try these solutions:

- Check the product control panel for error messages. If you have the notification email set when the events occur, you can promptly learn the status.
- Make sure the computer and product are connected to the same network (or network subnet/VLAN).
- If the product and computer cannot communicate and are connected to the same network (or network subnet/VLAN), check if your router or access point uses the privacy separator and disable it, if necessary. Follow the instructions in your router or access point documentation to disable the privacy separator.
- Move the product and computer or smart device closer to the router or access point.
- If you cannot scan from the  start button on the product, make sure you restarted your computer after installing the scanning software. Also start Epson Scan 2 before scanning with the  start button.
- If you are scanning a large original at a high resolution, a network communication error may occur. Try scanning again at a lower resolution.
- If network communication was interrupted while starting Epson Scan 2, exit Epson Scan 2, wait a few seconds, and restart the program. If Epson Scan 2 cannot restart, turn off your product, turn it back on, and try starting Epson Scan 2 again.
- Check the network connection setting in the Epson Scan 2 Utility.
- You may need to temporarily disable the firewall and any anti-virus software on your wireless router or access point.
- If you see the message "Network product is not available: currently being used by user", there may be a communication error between the product and computer. Restart the product.
- Epson Scan 2 does not support networks that use only IPv6. Use Epson Scan 2 on a network that supports IPv4.
- If the Firewall function is active, the product may not be discovered by the Epson Scan 2 Utility. Open the Epson Scan 2 Utility, enter the IP address for your product, and click **Add**.
- Restart the product and check the IP address on the product control panel.
- Make sure the router, switch, or hub is turned on.
- Restart the router, switch, or hub, wait for approximately one minute after restarting, then check the connection again.
- The order in which the router, access point, switch, or hub and product are turned on may cause a temporary connection error. Restart the product, wait for approximately one minute after restarting, then check the connection again.

- Make sure the Ethernet cable is securely connected to your product and to your router, switch, or hub. Check to see if the LED for the port to which your product is connected is on or flashing. If the link LED is off, try connecting your product to a different port on the router, switch, or hub or try changing the Ethernet cable.
- If you see a message telling you the product is not available, there may be a communication error between the product and computer. Restart the product.
- If there is an IP address conflict, the network connection may become unavailable. Check the IP address for each device and assign unique IP addresses.
- Restart the computer.

**Parent topic:** [Solving Network Scanning Problems](#)

#### **Related tasks**

[Starting a Scan Using the Product Control Panel](#)

[Starting a Scan from a Smartphone or Tablet](#)

[Starting a Scan Using the Epson Scan 2 Icon](#)

[Starting a Scan from a Scanning Program](#)

[Determining the Product's IP Address](#)

#### **Related topics**

[Scanning with Document Capture Pro or Document Capture](#)

## **Cannot Save a Scan to a Shared Folder Over a Network**

If you cannot save a scan to a shared folder when scanning over a network, or saving takes a very long time, try these solutions:

- Make sure that the computer is turned on and is not running in a power-saving mode, such as sleep or standby.
- Make sure you created a shared folder on your computer (Windows).
- Make sure the network folder does not already contain a file of the same name. If so, rename the file and try again.
- Make sure you added the correct user permissions.
- If you registered the shared folder path to your product's control panel contact list or entered the path manually to scan, make sure you used the correct path.
- Make sure the address in your product's control panel contact list and the address of the shared folder are the same.

- Make sure the user name and password are correct on the computer and product's control panel Contacts list. Also, make sure that the password has not expired.
- If you are using a laptop and the IP address is set to DHCP, the IP address may change when reconnecting to the network. Obtain the IP address again.
- Make sure your network type is not set to **Public network**. You cannot scan to a shared folder when using a public network. Set the forward settings for each port.
- If saving your scan to a shared folder takes a very long time, make sure the DNS setting and the DNS domain name are correct. Contact your network administrator for instructions.

**Parent topic:** [Solving Network Scanning Problems](#)

#### **Related tasks**

[Creating a Shared Network Folder](#)

[Registering Contacts for Email, Network, or FTP Scanning - Control Panel](#)

[Registering Contacts for Email, Network, or FTP Scanning - Web Config](#)

## **Solving Scanned Image Quality Problems**

Check these sections if a scanned image on your computer screen has a quality problem.

**Note:** For solutions when using Document Capture Pro (Windows) or Document Capture (Mac) software, see the Document Capture Pro (Windows) or Document Capture (Mac) help utility.

[Back of Original Image Appears in Scanned Image](#)

[Scanned Characters are Blurry](#)

[Characters are not Recognized During Conversion to Editable Text \(OCR\)](#)

[Ripple Patterns Appear in an Image](#)

[Spots or Lines Appear in All Scanned Images](#)

[Scanned Image is Cropped](#)

**Parent topic:** [Solving Problems](#)

### **Back of Original Image Appears in Scanned Image**

If an image from the back of a thin original appears in your scanned image, make sure you selected the correct Image Type setting for your original and select the **Text Enhancement** setting in Epson Scan 2. You can also select the **Remove Background** setting in Epson Scan 2.

**Note:** If you select **Color** as the Image Type setting, you can change the level from Standard to High to remove more of the background.

If the image is still visible, you can also try setting a lower level for **Edge Enhancement** or a higher level for **Noise Reduction**.

**Parent topic:** [Solving Scanned Image Quality Problems](#)

**Related references**

[Image Format Options](#)

**Related tasks**

[Scanning in Epson Scan 2](#)

## Scanned Characters are Blurry

If characters in your scanned images are blurry, try these solutions:

- Make sure you do not move the product or original while scanning.
- Operate the product on a flat, stable surface.
- Make sure the originals are ejecting properly.
- Adjust these Epson Scan 2 settings (if available) and try scanning again:
  - Select the **Text Enhancement** setting.
  - If the **Image Type** setting is **Black & White**, adjust the **Threshold** setting or change the **Edge Enhancement** and **Noise Reduction Level** settings.
  - Increase the **Resolution** setting.
  - Set the **Image Type** to **Grayscale**.
  - If you are scanning in JPEG format, change the compression level. Click **Options** in the Image Format menu and change the **Image Quality** setting.

**Parent topic:** [Solving Scanned Image Quality Problems](#)

**Related references**

[Image Format Options](#)

**Related tasks**

[Scanning in Epson Scan 2](#)

## Characters are not Recognized During Conversion to Editable Text (OCR)

If characters in your scanned images are not recognized during OCR conversion, try these solutions:

- Make sure your original is loaded straight on your product.
- Use an original with clear text.
- Adjust these Epson Scan 2 settings (if available) and try scanning again:
  - Select the correct **Image Type** setting.
  - Select or adjust the **Text Enhancement** setting.
  - If the **Image Type** is set to **Black & White**, adjust the **Threshold** setting.
  - Set the **Image Type** to **Grayscale**.
- Set the scanning resolution between 200 and 600 dpi.
- If the original document is in landscape mode, set the **Rotate** setting to **Auto** in Epson Scan 2.
- If you are using OCR software, check the manual for any additional adjustments.
- Scan thermal paper receipts as soon as possible. They may deteriorate due to age or friction.
- When saving to Microsoft Office or Searchable PDF files, check that the correct languages are selected. Check the language in each save setting window.

**Parent topic:** [Solving Scanned Image Quality Problems](#)

### Related references

[Image Format Options](#)

### Related tasks

[Scanning in Epson Scan 2](#)

## Ripple Patterns Appear in an Image

You may see a ripple pattern (called a moiré) in scanned images of printed documents. This is caused by interference from differing pitches in the scanner's screen and your original's halftone screen. To reduce this effect, adjust these Epson Scan 2 settings (if available) and try scanning again:

- Select the **Descreening** setting.
- Select a lower **Resolution** setting.

**Parent topic:** [Solving Scanned Image Quality Problems](#)

### Related references

[Image Format Options](#)

### Related tasks

[Scanning in Epson Scan 2](#)

## Spots or Lines Appear in All Scanned Images

If spots or lines appear in all your scanned images, try the following solutions:

- Clean the rollers and glass scanning surfaces inside your product using a genuine Epson cleaning kit or a soft, moist cloth.
- Remove any dirt from your original.
- Enable the **Detect Glass Dirt** setting in the Epson Scan 2 Utility. You can also enable Glass Dirt Detection on the product's control panel (**Settings > Scanner Settings > Glass Dirt Detection > On**).

**Note:** If glass dirt detection does not work correctly, adjust the setting. If the glass dirt alert screen appears after cleaning the inside of the product, check the glass surface again (scratches on the glass may be detected as a glass dirt).

**Parent topic:** [Solving Scanned Image Quality Problems](#)

### Related tasks

[Cleaning Inside Your Product](#)

## Scanned Image is Cropped

If the edges of a scanned image are cropped, try the following solutions:

- Select **Auto Detect** as the Document Size setting in Epson Scan 2, Document Capture Pro, or Document Capture.
- If the document size is not detected correctly using the **Auto Detect** setting, select the size of your original from the **Document Size** list.

**Note:** If the size you want to scan is not on the list, select **Customize** to create it manually (Windows only).

- In Epson Scan 2, select the **Main Settings** tab. Select **Document Size > Settings** and adjust the cropping area shown in the **Crop Margins for Size "Auto"** setting. In Document Capture Pro, select **Detailed Settings** from the Scan window. Click **Configuration** and select the **Document** tab. Adjust the cropping area shown in the **Crop Margins for Size "Auto"** setting.
- In Epson Scan 2, select the **Advanced Settings** tab. Make sure the **Edge Fill** setting is set to **None**.

**Parent topic:** [Solving Scanned Image Quality Problems](#)





## Related tasks

[Scanning in Epson Scan 2](#)

# Resetting the Epson Scan 2 Settings

If you continue to experience image quality problems after trying all possible solutions, you may need to reset the Epson Scan 2 settings using the Epson Scan 2 Utility.

1. Do one of the following to start the Epson Scan 2 Utility:
  - **Windows 11:** Click , then search for **Epson Scan 2 Utility** and select it.
  - **Windows 10:** Click  > **EPSON** > **Epson Scan 2 Utility**.
  - **Windows 8.x:** Navigate to the **Apps** screen and select **Epson Scan 2 Utility**.
  - **Windows 7:** Click , and select **All Programs**. Select **EPSON** > **Epson Scan 2** > **Epson Scan 2 Utility**.
  - **Mac:** Open the **Applications** folder, open the **Epson Software** folder, and select **Epson Scan 2 Utility**.
2. Click the **Other** tab.
3. Click **Reset** and confirm your choice.

**Note:** If resetting the Epson Scan 2 settings does not solve your problem, uninstall your scanner software and re-install it.

**Parent topic:** [Solving Problems](#)

## Related concepts

[Uninstall Your Product Software](#)

# Uninstall Your Product Software

If you have a problem that requires you to uninstall and re-install your software, follow the instructions for your operating system.



[Uninstalling Product Software - Windows](#)

[Uninstalling Product Software - Mac](#)

**Parent topic:** [Solving Problems](#)

## Uninstalling Product Software - Windows

You can uninstall and then re-install your product software to solve certain problems.

1. Exit all applications currently running on your computer.
2. Turn off the product.
3. Disconnect any interface cables.
4. Do the following to uninstall each of your scanning software programs and follow any on-screen instructions:
  - **Windows 11:** Click , then search for **Settings** and select it. Select **Apps** or **System > Apps & features**. Then select the program you want to uninstall and select **Uninstall**.
  - **Windows 10:** Click  and select  (Settings) > **Apps > Apps & features**. Select the product software program and click **Uninstall**.
  - **Windows 8.x:** Navigate to the **Apps** screen and select **Control Panel > Programs > Programs and Features**. Select the product software program and click **Uninstall/Change**.
  - **Windows 7:** Open the Windows **Control Panel** utility. Select **Programs and Features**. (In Classic view, select **Programs** and click **Uninstall a program**.) Select the product software program and click **Uninstall/Change**.
5. Restart your computer, then see the *Start Here* sheet to re-install your software.

**Note:** If you find that re-installing your product software does not solve a problem, contact Epson.

**Parent topic:** [Uninstall Your Product Software](#)

## Uninstalling Product Software - Mac

In most cases, you do not need to uninstall your product software before re-installing it. However, you can download the Uninstaller utility from the Epson support website to uninstall your product software as described here.

1. To download the Uninstaller utility, visit [epson.com/support](http://epson.com/support) (U.S.), [epson.ca/support](http://epson.ca/support) (Canada), or [latin.epson.com/support](http://latin.epson.com/support) (Latin America) and select your product.
2. Follow the instructions on the screen to install the Uninstaller utility.
3. Quit all applications currently running on your Mac.
4. Double-click the **Uninstaller** icon.

5. In the Epson Uninstaller screen, select the checkbox for each software program you want to uninstall.
6. Click **Uninstall**.
7. Follow the on-screen instructions to uninstall the software.
8. To reinstall your product software, see the *Start Here* sheet for instructions.

**Note:** If you find that re-installing your product software does not solve a problem, contact Epson.

**Parent topic:** [Uninstall Your Product Software](#)

## Where to Get Help (U.S. and Canada)

If you need to contact Epson for technical support services, use the following support options.

### Internet Support

Visit Epson's support website at [epson.com/support](http://epson.com/support) (U.S.) or [epson.ca/support](http://epson.ca/support) (Canada) and select your product for solutions to common problems with your product. You can download utilities and documentation, get FAQs and troubleshooting advice, or e-mail Epson with your questions.

### Speak to a Support Representative

Before you call Epson for support, please have the following information ready:

- Product name
- Product serial number (located on a label on the product)
- Proof of purchase (such as a store receipt) and date of purchase
- Computer configuration
- Description of the problem

Then call:

- U.S.: (562) 276-4300, 7 AM to 4 PM, Pacific Time, Monday through Friday
- Canada: (905) 709-3839, 7 AM to 4 PM, Pacific Time, Monday through Friday

Days and hours of support are subject to change without notice. Toll or long distance charges may apply.

**Note:** For help using any other software on your system, see the documentation for that software for technical support.

### Purchase Supplies and Accessories

You can purchase genuine Epson accessories at [epson.com](http://epson.com) (U.S. sales) or [epson.ca](http://epson.ca) (Canadian sales). You can also purchase accessories from an Epson authorized reseller. To find the nearest one, call 800-GO-EPSON (800-463-7766) in the U.S. or 800-807-7766 in Canada.

Parent topic: [Solving Problems](#)

## Where to Get Help (Latin America)

If you need to contact Epson for technical support services, use the following support options.

### Internet Support

Visit Epson's support website at [latin.epson.com/support](http://latin.epson.com/support) and select your product for solutions to common problems with your product. You can download utilities and documentation, get FAQs and troubleshooting advice, or e-mail Epson with your questions.

### Speak to a Support Representative

Before you call Epson for support, please have the following information ready:

- Product name
- Product serial number (located on a label on the product)
- Proof of purchase (such as a store receipt) and date of purchase
- Computer configuration
- Description of the problem

Then call:

Country	Telephone
Argentina	(54 11) 5167-0300 0800-288-37766
Bolivia*	800-100-116
Brazil	State capitals and metropolitan areas: 3004-6627 Other areas: 0800-377-6627 / 0800-EPSONBR
Chile	(56 2) 2484-3400

Country	Telephone
Colombia	Bogota: (57 1) 602-4751 Other cities: 01-8000-915235
Costa Rica	800-377-6627
Dominican Republic*	1-888-760-0068
Ecuador*	1-800-000-044
El Salvador*	800-6570
Guatemala*	1-800-835-0358
Mexico	Mexico City: (52 55) 1323-2052 Other cities: 800-087-1080
Nicaragua*	00-1-800-226-0368
Panama*	00-800-052-1376
Paraguay	009-800-521-0019
Peru	Lima: (51 1) 418-0210 Other cities: 0800-10126
Uruguay	00040-5210067
Venezuela	(58 212) 240-1111

\* Contact your local phone company to call this toll-free number from a mobile phone.

If your country does not appear in the list, contact the sales office in the nearest country. Toll or long distance charges may apply.

**Note:** For help using any other software on your system, see the documentation for that software for technical support.

### **Purchase Supplies and Accessories**

You can purchase genuine Epson accessories from an Epson authorized reseller. To find the nearest reseller, visit [latin.epson.com](http://latin.epson.com) or call your nearest Epson sales office.

**Parent topic:** [Solving Problems](#)

---

# Technical Specifications

These sections list the technical specifications for your product.

**Note:** Epson offers a recycling program for end of life Epson products. Please go to [this site](#) (U.S.) or [this site](#) (Canada) for information on how to return your Epson products for proper disposal.

[Windows System Requirements](#)

[Mac System Requirements](#)

[General Specifications](#)

[Dimension Specifications](#)

[Electrical Specifications](#)

[Environmental Specifications](#)

[Network Interface Specifications](#)

[Safety and Approvals Specifications](#)

## Windows System Requirements

To use your product and its software, your computer should use one of these Microsoft operating systems:

- Windows 11
- Windows 10
- Windows 8.x
- Windows 7

**Note:** For the latest product software available for your operating system, visit the Epson support site at [epson.com/support](#) (U.S.), [epson.ca/support](#) (Canada), or [latin.epson.com/support](#) (Latin America), select your product, and select **Downloads**.

**Parent topic:** [Technical Specifications](#)

## Mac System Requirements

To use your product and its software, your Mac should use one of these operating systems:

- macOS 12.x

- macOS 11.x
- macOS 10.15.x
- macOS 10.14.x
- macOS 10.13.x
- macOS 10.12.x
- OS X 10.11.x
- OS X 10.10.x

**Note:** The UNIX File System (UFS) for OS X and Fast User Switching on OS X is not supported.

For the latest product software available for your operating system, visit the Epson support site at [epson.com/support](http://epson.com/support) (U.S.), [epson.ca/support](http://epson.ca/support) (Canada), or [latin.epson.com/support](http://latin.epson.com/support) (Caribbean), select your product, and select **Downloads**.

**Parent topic:** [Technical Specifications](#)

## General Specifications

<b>Scanner type</b>	Sheet feed, one pass duplex, color
<b>Photoelectric device</b>	CIS
<b>Effective pixels</b>	5100 × 9300 pixels at 600 dpi 2550 × 64,500 pixels at 300 dpi
<b>Document size</b>	Maximum: 8.5 × 240 inches (215.9 × 6096 mm) Minimum: 2 × 2 inches (50.8 × 50.8 mm)
	<b>Note:</b> Maximum length may vary depending on the scanning method and resolution.
<b>Paper input</b>	Facedown loading
<b>Paper output</b>	Facedown ejection
<b>Paper capacity</b>	100 sheets of paper at 21 lb (80 g/m <sup>2</sup> ) weight
<b>Scanning resolution</b>	600 dpi (main scan) 600 dpi (sub scan)

**Output resolution** 50 to 1200 dpi in 1 dpi increments (when scanning with a computer)

**Note:** Available resolutions may vary depending on the scanning method.

**Color Depth**

Color:

30 bits per pixel internal (10 bits per pixel per color)

24 bits per pixel external (8 bits per pixel per color)

Grayscale:

10 bits per pixel internal

8 bits per pixel external

Black-and-white:

10 bits per pixel internal

1 bit per pixel external

**Interface**

SuperSpeed USB 3.0 (backward-compatible with USB 1.1)

Hi-speed USB (Host)

IEEE802.11b/g/n or IEEE802.11a/b/g/n/ac

**Note:** Available Wi-Fi interfaces vary depending on your region.

Ethernet 1000BASE-T/100BASE-TX/10BASE-T

**Light source**

RGB LED

Parent topic: [Technical Specifications](#)

## Dimension Specifications

<b>Height</b>	6.6 inches (167 mm)
<b>Width</b>	11.7 inches (296 mm)
<b>Depth</b>	6.7 inches (169 mm)
<b>Weight</b>	8.2 lb (3.7 kg)



**Note:** Dimensions do not include projecting parts.

Parent topic: [Technical Specifications](#)

## Electrical Specifications

### Scanner

**Note:** Check the label on the product and the AC adapter for voltage information. Power consumption varies depending on operating conditions or whether an option is installed.

**Rated DC input power supply voltage** DC 24 V

**Rated DC input current** 1 A

**Power consumption**

**USB Connection:**

Operating: 15 W (approximate)

Ready mode: 5 W (approximate)

Sleep mode: 1.3 W (approximate)

Power off mode: 0.1 W (approximate)

**Wi-Fi Connection:**

Operating: 15 W (approximate)

Ready mode: 5 W (approximate)

Sleep mode: 1.6 W (approximate)

Power off mode: 0.1 W (approximate)

**Ethernet Connection:**

Operating: 15 W (approximate)

Ready mode: 5.3 W (approximate)

Sleep mode: 1.5 W (approximate)

Power off mode: 0.1 W (approximate)

## AC Adapter

<b>AC adapter model</b>	100 to 240 V model: A461H
<b>Rated input current</b>	1 A
<b>Rated frequency range</b>	50 to 60 Hz
<b>Rated output power supply voltage</b>	DC 24 V
<b>Rated output current</b>	1 A

Parent topic: [Technical Specifications](#)

## Environmental Specifications

<b>Temperature</b>	Operating: 41 to 95 °F (5 to 35 °C) Storage: –13 to 140 °F (–25 to 60 °C)
<b>Humidity</b> (non-condensing)	Operating: 15 to 80% RH Storage: 15 to 85% RH
<b>Operating conditions</b>	Ordinary office or home conditions

**Note:** Avoid operating the product in direct sunlight, near a strong light source, or in extremely dusty conditions.

Parent topic: [Technical Specifications](#)

## Network Interface Specifications

### Wi-Fi

<b>Standards</b>	IEEE802.11a/b/g/n/ac; IEEE802.11n available only on the 20 MHz channel
<b>Frequency ranges</b>	IEEE802.11b/g/n: 2.4 GHz IEEE802.11a/n/ac: 5 GHz

<b>Wi-Fi channels</b>	<p>2.4 GHz: 1/2/3/4/5/6/7/8/9/10/11/12/13</p> <p>5 GHz: W52 (36/40/44/48) W53 (52/56/60/64) W56 (100/104/108/112/116/120/124/128/132/136/140/144) W58 (149/153/157/161/165)</p>
<b>Connection modes</b>	<p>Infrastructure mode Wi-Fi Direct (Simple AP); not supported for IEEE802.11b</p> <p><b>Note:</b> Infrastructure and Wi-Fi Direct modes or an Ethernet connection can be used simultaneously.</p>
<b>Maximum radio frequency power transmitted</b>	2400-2483.5 MHz: 20 dBm (EIRP)
<b>Wireless security protocols</b>	<p>WEP (64/128 bit) WPA2-PSK (AES); complies with WPA2 standards with support for WPA/WPA2 Personal WPA3-SAE (AES) WPA2/WPA3-Enterprise; WPA2 compliant with support for WPA/WPA2 Enterprise</p> <p><b>Note:</b> Wi-Fi Direct supports only WPA2-PSK (AES).</p>
<b>Ethernet</b>	
<b>Standards</b>	<p>IEEE802.3i (10BASE-T)* IEEE802.3u (100BASE-TX)* IEEE802.3ab (1000BASE-T)* IEEE802.3az (Energy Efficient Ethernet); connected device should be IEEE802.3az compliant</p>
<b>Communication mode</b>	Auto, 10 Mbps Full duplex, 10Mbps Half duplex, 100 Mbps Full Duplex, 100 Mbps Half duplex

**Connector** RJ-45

\* Use a category 5e or higher STP (Shielded twisted pair) cable to prevent risk of radio interference.

**Security Protocol**

SSL/TLS	HTTPS (Server/Client) SMTPS (Client) STARTTLS SNMPv3
MIB accessing Authentication/Encryption	SNMPv3

Parent topic: [Technical Specifications](#)

## Safety and Approvals Specifications

**Scanner**

<b>United States</b>	EMC: FCC part 15 Subpart B class B
<b>Canada</b>	EMC: CAN ICES-3 (B)/NMB-3 (B)

**AC Adapter (A461H)**

<b>United States</b>	Safety: UL60950-1 EMC: FCC part 15 Subpart B class B
<b>Canada</b>	Safety: CAN/CSA C22.2 No. 60950-1 EMC: CAN ICES-3 (B)/NMB-3 (B)

This equipment contains the following wireless module:

- Manufacturer: Seiko Epson Corporation.
- Type: J26H005

This product conforms to Part 15 of the FCC Rules and RSS-210 of the IC Rules. Epson cannot accept responsibility for any failure to satisfy the protection requirements resulting from a non-recommended modification of the product. Operation is subject to the following two conditions: (1) this device may not cause harmful interference, and (2) this device must accept any interference received, including interference that may cause undesired operation of the device.

To prevent radio interference to the licensed service, this device is intended to be operated indoors and away from windows to provide maximum shielding. Equipment (or its transmit antenna) that is installed outdoors is subject to licensing.

This equipment complies with FCC/IC radiation exposure limits set forth for an uncontrolled environment and meets the FCC radio frequency (RF) Exposure Guidelines in Supplement C to OET65 and RSS-102 of the IC radio frequency (RF) Exposure rules. This equipment should be installed and operated so that the radiator is kept at least 7.9 inches (20 cm) or more away from a person's body (excluding extremities: hands, wrists, feet and ankles).

#### **Notice for Mexico**

Operation is subject to the following two conditions: (1) this device may not cause harmful interference, and (2) this device must accept any interference received, including interference that may cause undesired operation of the device.

Product Model: J382G (DS-790WN)

WLAN Module Model: J26H005

Brand: EPSON

IFT Certification Number: RCPEPJ219-2102

#### **Notice for Paraguay**

Imported by:

Fastrax, S.A.

Av. Perú esq. Río de Janeiro, Barrios Las Mercedes, Asunción, Paraguay

Imported by:

Sol Control S.R.L.

Av. Gral. Bernardino Caballero 810 esq. Celsa Speratti, Asunción, Paraguay

#### **Notice for Peru**

Product Model: DS-790WN (J382G )

Brand: EPSON

This product uses the following WLAN module:

WLAN Module Model: J26H005

FCC ID: BKMFBJ26H005

Product Manufacturer: Seiko Epson Corporation

Address: 3-3-5 Owa Suwa-shi, Nagano-Ken 392-8502, Japan

**Parent topic:** [Technical Specifications](#)

---

## Notices

Check these sections for important notices about your product.

**Note:** Epson offers a recycling program for end of life Epson products. Please go to [this site](#) (U.S.) or [this site](#) (Canada) for information on how to return your Epson products for proper disposal.

[Important Safety Instructions](#)

[Restrictions on Copying](#)

[Default Delay Times for Power Management for Epson Products](#)

[Binding Arbitration and Class Waiver](#)

[Trademarks](#)

[Copyright Notice](#)

## Important Safety Instructions

Follow these safety instructions when setting up and using the product.

- Read all these instructions, and follow all warnings and instructions marked on the product.
- Place the product close enough to the computer for the interface cable to reach it easily.
- Do not place or store the product outdoors, in a car, near excessive dirt or dust, water, heat sources, or in locations subject to shocks, vibrations, condensation, high temperature or humidity, direct sunlight, strong light sources, or rapid changes in temperature or humidity.
- Do not use with wet hands.
- When connecting this product to a computer or other device with a cable, ensure the correct orientation of the connectors. Each connector has only one correct orientation. Inserting a connector in the wrong orientation may damage both devices connected by the cable.
- Do not insert objects into any opening as they may touch dangerous voltage points or short out parts. Beware of electrical shock hazards.
- Place the product on a flat, stable surface that extends beyond the base of the product in all directions. If you place the product by the wall, leave at least 3.9 inches (10 cm) between the back of the product and the wall.
- After replacing consumable parts, dispose of them correctly following the rules of your local authority. Do not disassemble them.

- Never disassemble, modify, or attempt to repair the product or a product option by yourself except as specifically explained in this guide.

**Caution:** Radio waves from this product may adversely affect the operation of medical equipment, airplanes, or automatically controlled devices, such as pacemakers, automatic doors, or fire alarms. When using this product near such devices or inside a medical facility, follow the directions from authorized staff members at the facility, and follow all posted warnings and directions on the device to avoid causing an accident.

### **AC Adapter**

- Do not place or store the AC adapter outdoors, in a car, near excessive dirt or dust, water, heat sources, or in locations subject to shocks, vibrations, condensation, high temperature or humidity, direct sunlight, strong light sources, or rapid changes in temperature or humidity.
- Place the product and the AC adapter near an electrical outlet where the adapter can be easily unplugged.
- The AC power cord should be placed to avoid abrasions, cuts, fraying, crimping, and kinking.
- Do not place objects on top of the AC power cord and do not allow the AC adapter or the power cord to be stepped on or run over. Be particularly careful to keep the AC power cord straight at the end and the point where it enters the AC adapter.
- Use only the AC adapter that comes with your product. Using any other adapter could cause fire, electrical shock, or injury.
- Use only the power cord that comes with your product. Use of another cord may cause fires or shock. Do not use the cord with any other equipment.
- The AC adapter is designed for use with the product with which it was included. Do not attempt to use it with other electronic devices unless specified.
- Use only the type of power source indicated on the AC adapter's label, and always supply power directly from a standard domestic electrical outlet with the AC adapter that meets the relevant local safety standards.
- Avoid using outlets on the same circuit as photocopiers or air control systems that regularly switch on and off.
- If you use an extension cord with the product, make sure the total ampere rating of the devices plugged into the extension cord does not exceed the cord's ampere rating. Also, make sure the total ampere rating of all devices plugged into the wall outlet does not exceed the wall outlet's ampere rating.



- Never disassemble, modify, or attempt to repair the AC adapter by yourself except as specifically explained in the product's guides.
- If damage occurs to the plug, replace the cord set or consult a qualified electrician. If there are fuses in the plug, make sure you replace them with fuses of the correct size and rating.
- Unplug the product and the AC adapter, and refer servicing to qualified service personnel under the following conditions: The AC adapter or plug is damaged; liquid has entered the product or the AC adapter; the product or the AC adapter has been dropped or the case has been damaged; the product or the AC adapter does not operate normally or exhibits a distinct change in performance. (Do not adjust controls that are not covered by the operating instructions.)
- Unplug the product and the AC adapter before cleaning. Clean with a damp cloth only. Do not use liquid or aerosol cleaners.
- If you are not going to use the product for a long period, be sure to unplug the AC adapter from the electrical outlet.

### **USB**

- The USB cable is designed for use with the product with which it was included. Do not attempt to use it with other electrical devices unless specified.
- The USB cable should be placed to avoid abrasions, cuts, fraying, crimping, and kinking.
- Do not place objects on top of the USB cable and do not allow the cable to be stepped on or run over. Be particularly careful to keep the USB cable straight at the end.
- If you are not going to use the product for a long period, unplug the USB cable from the computer.
- Unplug the product and the USB cable, and refer servicing to qualified service personnel under the following conditions: Liquid has entered the product; the product has been dropped or the case has been damaged; the product does not operate normally or exhibits a distinct change in performance. (Do not adjust controls that are not covered by the operating instructions.)

### **LCD Screen**

- The LCD screen may have uneven brightness or a few small bright or dark spots. This is normal and does not indicate damage.
- Use only a dry, soft cloth to clean the LCD screen. Do not use liquid or chemical cleansers.
- If the LCD screen is damaged, contact Epson. If the liquid crystal solution gets on your hands, wash them thoroughly with soap and water. If the liquid crystal solution gets into your eyes, flush them immediately with water. If discomfort or vision problems remain after a thorough flushing, see a doctor immediately.
- Do not press too hard on the LCD screen or subject it to heavy impacts.

- Do not use a pointy or sharp object, such as a pen or your fingernail, to operate the LCD screen.
- If the LCD screen chips or cracks, do not touch or attempt to remove the broken pieces; contact Epson for support.
- Do not subject your product to sudden changes in temperature or humidity; this may cause condensation to develop inside the LCD screen and degrade its performance.

**Parent topic:** [Notices](#)

## Restrictions on Copying

Observe the following restrictions to ensure responsible and legal use of your scanner.

Copying of the following items is prohibited by law:

- Bank bills, coins, government-issued marketable securities, government bond securities, and municipal securities
- Unused postage stamps, pre-stamped postcards, and other official postal items bearing valid postage
- Government-issued revenue stamps, and securities issued according to legal procedure

Exercise caution when copying the following items:

- Private marketable securities (stock certificates, negotiable notes, checks, etc.), monthly passes, concession tickets, etc.
- Passports, driver's licenses, warrants of fitness, road passes, food stamps, tickets, etc.

**Note:** Copying these items may also be prohibited by law.

### Restriction on disassembling and decompiling

You may not disassemble, decompile, or otherwise attempt to derive the source code of any software included with this product.

**Parent topic:** [Notices](#)

## Default Delay Times for Power Management for Epson Products

This product will enter sleep mode after a period of nonuse. This is to ensure that the product meets Energy Star standards of energy efficiency. More energy savings can be achieved by setting the time to sleep to a shorter interval.

**Parent topic:** [Notices](#)

# Binding Arbitration and Class Waiver

## 1. DISPUTES, BINDING INDIVIDUAL ARBITRATION, AND WAIVER OF CLASS ACTIONS AND CLASS ARBITRATIONS

1.1 **Disputes.** The terms of this Section 1 shall apply to all Disputes between you and Epson. The term "Dispute" is meant to have the broadest meaning permissible under law and includes any dispute, claim, controversy or action between you and Epson arising out of or relating to this Agreement, Epson branded products (hardware and including any related software), or other transaction involving you and Epson, whether in contract, warranty, misrepresentation, fraud, tort, intentional tort, statute, regulation, ordinance, or any other legal or equitable basis. "DISPUTE" DOES NOT INCLUDE IP CLAIMS, or more specifically, a claim or cause of action for (a) trademark infringement or dilution, (b) patent infringement, (c) copyright infringement or misuse, or (d) trade secret misappropriation (an "IP Claim"). You and Epson also agree, notwithstanding Section 1.6, that a court, not an arbitrator, may decide if a claim or cause of action is for an IP Claim.

1.2 **Binding Arbitration.** You and Epson agree that all Disputes shall be resolved by binding arbitration according to this Agreement. **ARBITRATION MEANS THAT YOU WAIVE YOUR RIGHT TO A JUDGE OR JURY IN A COURT PROCEEDING AND YOUR GROUNDS FOR APPEAL ARE LIMITED.** Pursuant to this Agreement, binding arbitration shall be administered by JAMS, a nationally recognized arbitration authority, pursuant to its code of procedures then in effect for consumer related disputes, but excluding any rules that permit joinder or class actions in arbitration (for more detail on procedure, see Section 1.6 below). You and Epson understand and agree that (a) the Federal Arbitration Act (9 U.S.C. §1, et seq.) governs the interpretation and enforcement of this Section 1, (b) this Agreement memorializes a transaction in interstate commerce, and (c) this Section 1 shall survive termination of this Agreement.

1.3 **Pre-Arbitration Steps and Notice.** Before submitting a claim for arbitration, you and Epson agree to try, for sixty (60) days, to resolve any Dispute informally. If Epson and you do not reach an agreement to resolve the Dispute within the sixty (60) days, you or Epson may commence an arbitration. Notice to Epson must be addressed to: Epson America, Inc., ATTN: Legal Department, 3131 Katella Ave., Los Alamitos, CA 90720 (the "Epson Address"). The Dispute Notice to you will be sent to the most recent address Epson has in its records for you. For this reason, it is important to notify us if your address changes by emailing us at [EAILEgal@ea.epson.com](mailto:EAILEgal@ea.epson.com) or writing us at the Epson Address above. Notice of the Dispute shall include the sender's name, address and contact information, the facts giving rise to the Dispute, and the relief requested (the "Dispute Notice"). Following receipt of the Dispute Notice, Epson and you agree to act in good faith to resolve the Dispute before commencing arbitration.

1.4 **Small Claims Court.** Notwithstanding the foregoing, you may bring an individual action in the small claims court of your state or municipality if the action is within that court's jurisdiction and is pending only in that court.

**1.5 WAIVER OF CLASS ACTIONS AND CLASS ARBITRATIONS. YOU AND EPSON AGREE THAT EACH PARTY MAY BRING DISPUTES AGAINST THE OTHER PARTY ONLY IN AN INDIVIDUAL CAPACITY, AND NOT AS A PLAINTIFF OR CLASS MEMBER IN ANY CLASS OR REPRESENTATIVE PROCEEDING, INCLUDING WITHOUT LIMITATION FEDERAL OR STATE CLASS ACTIONS, OR CLASS ARBITRATIONS. CLASS ACTION LAWSUITS, CLASS-WIDE ARBITRATIONS, PRIVATE ATTORNEY-GENERAL ACTIONS, AND ANY OTHER PROCEEDING WHERE SOMEONE ACTS IN A REPRESENTATIVE CAPACITY ARE NOT ALLOWED. ACCORDINGLY, UNDER THE ARBITRATION PROCEDURES OUTLINED IN THIS SECTION, AN ARBITRATOR SHALL NOT COMBINE OR CONSOLIDATE MORE THAN ONE PARTY'S CLAIMS WITHOUT THE WRITTEN CONSENT OF ALL AFFECTED PARTIES TO AN ARBITRATION PROCEEDING.**

**1.6 Arbitration Procedure.** If you or Epson commences arbitration, the arbitration shall be governed by the rules of JAMS that are in effect when the arbitration is filed, excluding any rules that permit arbitration on a class or representative basis (the "JAMS Rules"), available at <http://www.jamsadr.com> or by calling 1-800-352-5267, and under the rules set forth in this Agreement. All Disputes shall be resolved by a single neutral arbitrator, and both parties shall have a reasonable opportunity to participate in the selection of the arbitrator. The arbitrator is bound by the terms of this Agreement. The arbitrator, and not any federal, state or local court or agency, shall have exclusive authority to resolve all disputes arising out of or relating to the interpretation, applicability, enforceability or formation of this Agreement, including any claim that all or any part of this Agreement is void or voidable. Notwithstanding this broad delegation of authority to the arbitrator, a court may determine the limited question of whether a claim or cause of action is for an IP Claim, which is excluded from the definition of "Disputes" in Section 1.1 above. The arbitrator shall be empowered to grant whatever relief would be available in a court under law or in equity. The arbitrator may award you the same damages as a court could, and may award declaratory or injunctive relief only in favor of the individual party seeking relief and only to the extent necessary to provide relief warranted by that party's individual claim. In some instances, the costs of arbitration can exceed the costs of litigation and the right to discovery may be more limited in arbitration than in court. The arbitrator's award is binding and may be entered as a judgment in any court of competent jurisdiction.

You may choose to engage in arbitration hearings by telephone. Arbitration hearings not conducted by telephone shall take place in a location reasonably accessible from your primary residence, or in Orange County, California, at your option.

a) Initiation of Arbitration Proceeding. If either you or Epson decides to arbitrate a Dispute, both parties agree to the following procedure:

(i) Write a Demand for Arbitration. The demand must include a description of the Dispute and the amount of damages sought to be recovered. You can find a copy of a Demand for Arbitration at <http://www.jamsadr.com> ("Demand for Arbitration").

(ii) Send three copies of the Demand for Arbitration, plus the appropriate filing fee, to: JAMS, 500 North State College Blvd., Suite 600 Orange, CA 92868, U.S.A.

(iii) Send one copy of the Demand for Arbitration to the other party (same address as the Dispute Notice), or as otherwise agreed by the parties.

b) Hearing Format. During the arbitration, the amount of any settlement offer made shall not be disclosed to the arbitrator until after the arbitrator determines the amount, if any, to which you or Epson is entitled. The discovery or exchange of non-privileged information relevant to the Dispute may be allowed during the arbitration.

c) Arbitration Fees. Epson shall pay, or (if applicable) reimburse you for, all JAMS filings and arbitrator fees for any arbitration commenced (by you or Epson) pursuant to provisions of this Agreement.

d) Award in Your Favor. For Disputes in which you or Epson seeks \$75,000 or less in damages exclusive of attorney's fees and costs, if the arbitrator's decision results in an award to you in an amount greater than Epson's last written offer, if any, to settle the Dispute, Epson will: (i) pay you \$1,000 or the amount of the award, whichever is greater; (ii) pay you twice the amount of your reasonable attorney's fees, if any; and (iii) reimburse you for any expenses (including expert witness fees and costs) that your attorney reasonably accrues for investigating, preparing, and pursuing the Dispute in arbitration. Except as agreed upon by you and Epson in writing, the arbitrator shall determine the amount of fees, costs, and expenses to be paid by Epson pursuant to this Section 1.6d).

e) Attorney's Fees. Epson will not seek its attorney's fees and expenses for any arbitration commenced involving a Dispute under this Agreement. Your right to attorney's fees and expenses under Section 1.6d) above does not limit your rights to attorney's fees and expenses under applicable law; notwithstanding the foregoing, the arbitrator may not award duplicative awards of attorney's fees and expenses.

**1.7 Opt-out. You may elect to opt-out (exclude yourself) from the final, binding, individual arbitration procedure and waiver of class and representative proceedings specified in this Agreement by sending a written letter to the Epson Address within thirty (30) days of your assent to this Agreement (including without limitation the purchase, download, installation of the Software or other applicable use of Epson Hardware, products and services) that specifies (i) your name, (ii) your mailing address, and (iii) your request to be excluded from the final, binding individual arbitration procedure and waiver of class and representative proceedings specified in this Section 1. In the event that you opt-out consistent with the procedure set forth above, all other terms shall continue to apply, including the requirement to provide notice prior to litigation.**

**1.8 Amendments to Section 1.** Notwithstanding any provision in this Agreement to the contrary, you and Epson agree that if Epson makes any future amendments to the dispute resolution procedure and class action waiver provisions (other than a change to Epson's address) in this Agreement, Epson will obtain your affirmative assent to the applicable amendment. If you do not affirmatively assent to the applicable amendment, you are agreeing that you will arbitrate any Dispute between the parties in accordance with the language of this Section 1 (or resolve disputes as provided for in Section 1.7, if you timely elected to opt-out when you first assented to this Agreement).

**1.9 Severability.** If any provision in this Section 1 is found to be unenforceable, that provision shall be severed with the remainder of this Agreement remaining in full force and effect. **The foregoing shall not apply to the prohibition against class or representative actions as provided in Section 1.5. This means that if Section 1.5 is found to be unenforceable, the entire Section 1 (but only Section 1) shall be null and void.**

Parent topic: [Notices](#)

## Trademarks

EPSON® and Epson Smart Panel® are registered trademarks, the EPSON logo is a registered logomark, and Epson Connect™ is a trademark of Seiko Epson Corporation.

Apple, App Store, Mac, macOS, OS X, and AirPrint are trademarks of Apple Inc., registered in the U.S. and other countries.

Google® is a registered trademark and Android™ and Google Play™ are trademarks of Google LLC.

Microsoft and Windows are trademarks of the Microsoft group of companies.

Wi-Fi Direct® is a registered trademark of Wi-Fi Alliance®.

General Notice: Other product names used herein are for identification purposes only and may be trademarks of their respective owners. Epson disclaims any and all rights in those marks.

The EPSON logo is displayed in a bold, blue, sans-serif font. The letters are evenly spaced and the 'P' has a distinctive shape with a vertical bar on its right side. A registered trademark symbol (®) is located at the top right of the 'N'.

Parent topic: [Notices](#)

## Copyright Notice

All rights reserved. No part of this publication may be reproduced, stored in a retrieval system, or transmitted in any form or by any means, electronic, mechanical, photocopying, recording, or otherwise, without the prior written permission of Seiko Epson Corporation. The information contained herein is designed only for use with this Epson product. Epson is not responsible for any use of this information as applied to other products.

Neither Seiko Epson Corporation nor its affiliates shall be liable to the purchaser of this product or third parties for damages, losses, costs, or expenses incurred by purchaser or third parties as a result of: accident, misuse, or abuse of this product or unauthorized modifications, repairs, or alterations to this product, or (excluding the U.S.) failure to strictly comply with Seiko Epson Corporation's operating and maintenance instructions.

Seiko Epson Corporation shall not be liable for any damages or problems arising from the use of any options or any consumable products other than those designated as Original Epson Products or Epson Approved Products by Seiko Epson Corporation.

Seiko Epson Corporation shall not be held liable for any damage resulting from electromagnetic interference that occurs from the use of any interface cables other than those designated as Epson approved Products by Seiko Epson Corporation.

This information is subject to change without notice.

[libTIFF Software Acknowledgment](#)

[A Note Concerning Responsible Use of Copyrighted Materials](#)

[Copyright Attribution](#)

**Parent topic:** [Notices](#)

## **libTIFF Software Acknowledgment**

Copyright © 1988-1997 Sam Leffler

Copyright © 1991-1997 Silicon Graphics, Inc.

Permission to use, copy, modify, distribute, and sell this software and its documentation for any purpose is hereby granted without fee, provided that (I) the above copyright notices and this permission notice appear in all copies of the software and related documentation, and (ii) the names of Sam Leffler and Silicon Graphics may not be used in any advertising or publicity relating to the software without the specific, prior written permission of Sam Leffler and Silicon Graphics.

THE SOFTWARE IS PROVIDED "AS-IS" AND WITHOUT WARRANTY OF ANY KIND, EXPRESS, IMPLIED OR OTHERWISE, INCLUDING WITHOUT LIMITATION, ANY WARRANTY OF MERCHANTABILITY OR FITNESS FOR A PARTICULAR PURPOSE.

IN NO EVENT SHALL SAM LEFFLER OR SILICON GRAPHICS BE LIABLE FOR ANY SPECIAL, INCIDENTAL, INDIRECT OR CONSEQUENTIAL DAMAGES OF ANY KIND, OR ANY DAMAGES WHATSOEVER RESULTING FROM LOSS OF USE, DATA OR PROFITS, WHETHER OR NOT ADVISED OF THE POSSIBILITY OF DAMAGE, AND ON ANY THEORY OF LIABILITY, ARISING OUT OF OR IN CONNECTION WITH THE USE OR PERFORMANCE OF THIS SOFTWARE.

**Parent topic:** [Copyright Notice](#)

## **A Note Concerning Responsible Use of Copyrighted Materials**

Epson encourages each user to be responsible and respectful of the copyright laws when using any Epson product. While some countries' laws permit limited copying or reuse of copyrighted material in certain circumstances, those circumstances may not be as broad as some people assume. Contact your legal advisor for any questions regarding copyright law.

**Parent topic:** [Copyright Notice](#)

## **Copyright Attribution**

© 2023 Epson America, Inc.

12/23

CPD-61515R1

**Parent topic:** [Copyright Notice](#)