

DesignMax DM10S-SUB

surface-mounted subwoofer

Product Overview

Delivering rich low-end performance, 300-watt DM10S-SUB subwoofer brings instantly impressive bass to any commercial sound installation. The surface-mounted DM10S-SUB has a 10-inch woofer, 35 Hz - 125 Hz frequency range, and locks onto a hidden QuickHold U-bracket. DesignMax subwoofers complement and enhance any DesignMax installation.



Key Features

Combine DesignMax models to complete any design, big or small – 12 loudspeakers to mix and match, from 2-inch, low-profile models to 8-inch, high-SPL compression-driver loudspeakers and outdoor-rated options.

Deliver rich bass performance with custom drivers; for optimal performance use select Bose Professional DSPs and amplifiers to enable Bose Professional loudspeaker EQ and SmartBass processing, which expands performance and response at any listening level.

Blend with any room design with elegant form factors, minimum-bezel grilles available in black or white, and removable logos.

Reduce installation time with the patented QuickHold mounting system, which also reduces strain, hassle, and the chance of product damage.

Install easily with industry-standard accessories – all models include Euroblock connectors; in-ceiling models include plenum-rated backcans, tile bridges, and front-access audio wiring that makes installation and troubleshooting easier.

Technical Specifications

SINGLE LOUDSPEAKER PERFORMANCE		
Frequency Response (-3 dB) ⁽¹⁾	41 - 108 Hz	
Frequency Range (-10 dB) ⁽¹⁾	35 - 125 Hz	
Nominal Coverage (1 - 10 kHz)	Omnidirectional below 200 Hz	
Nominal Coverage Angle (1 - 10 kHz)	Omnidirectional below 200 Hz	
	AES component test ⁽⁴⁾	Bose Professional extended-lifecycle test ⁽⁵⁾
Power Handling, long-term continuous	300 W	250 W
Power Handling, peak	1200 W	1000 W
Sensitivity (SPL/ 1W @ 1 m) ⁽²⁾	90 dB	90 dB
Calculated Maximum SPL @ 1 m ⁽³⁾	115 dB	114 dB
Calculated Maximum SPL @ 1 m, peak	121 dB	120 dB
Recommended Crossover	80 - 200 Hz (requires active crossover in DSP)	
Recommended High-Pass Protection	40 Hz with recommended 18 dB / octave filter	
Overload protection	Resistor-network power reduction with automatic reset	
Transformer taps	70V: 20, 40, 80, 150 W, bypass 100V: 40, 80, 150 W, bypass	
TRANSDUCERS		
Low Frequency	1 x 10-inch woofer (254 mm)	
Nominal Impedance	8 ohms (transformer bypass)	

DesignMax DM10S-SUB

surface-mounted subwoofer

PHYSICAL	
Enclosure Material	High-density wood composite with solid color laminate, UV fade resistant
Grille	Perforated steel, powder-coated finish, paintable, tamper-resistant design
Logo	Rotatable, removable
Color	Black: RAL 9005, White: RAL 9003, Paintable
Environmental / Ingress-Protection	Indoor only
Safety Agency	UL-1480A, S5591/ UL Listed, NFPA70, CE compliant
Operating Temperature Range	0 °C to 50 °C (32 °F to 122 °F)
Connectors	Euroblock 6-pin connector with loop-through, mounted on rear. Accepts 18 AWG (0.8 mm ²) to 14 AWG (2.5 mm ²) size wire
Suspension / Mounting	QuickHold Mounting System with included U-Bracket
	2 repeatable mounting angles: 0°, 90° for wall or ceiling placement
	One (1) rear M8 screw insert for safety-tether attachment
Dimensions (H × W × D)	502 × 316 × 323 mm (19.8 × 12.5 × 12.7 in)
Dimensions (H × W × D) with bracket	502 × 316 × 346 mm (19.8 × 12.5 × 13.6 in)
Net Weight, Loudspeaker with grille and bracket	16.1 kg (35.5 lb)
Shipping Weight	18.8 kg (41.5 lb)
Included Accessories	U-Bracket
Optional Accessories	None
PRODUCT CODES	
831856-0110	DESIGNMAX DM10S-SUB SINGLE BLK
831856-0210	DESIGNMAX DM10S-SUB SINGLE WHT

Footnotes

- (1) Frequency response and range measured on-axis in half-space environment with Bose Professional EQ voicing
- (2) Sensitivity measured on-axis in half-space environment with Bose Professional EQ voicing
- (3) Maximum SPL calculated from sensitivity and power handling specifications, exclusive of power compression
- (4) AES standard 2-hour duration with IEC system noise
- (5) Bose Professional extended-lifecycle test using pink noise filtered to meet IEC268-5, 6-dB crest factor, 500-hour duration
- (6) Frequency response shown using 40 Hz HPF 18 dB/octave and 100 Hz LPF 18 dB/octave

DesignMax DM10S-SUB

surface-mounted subwoofer

On-Axis Frequency Response ⁶

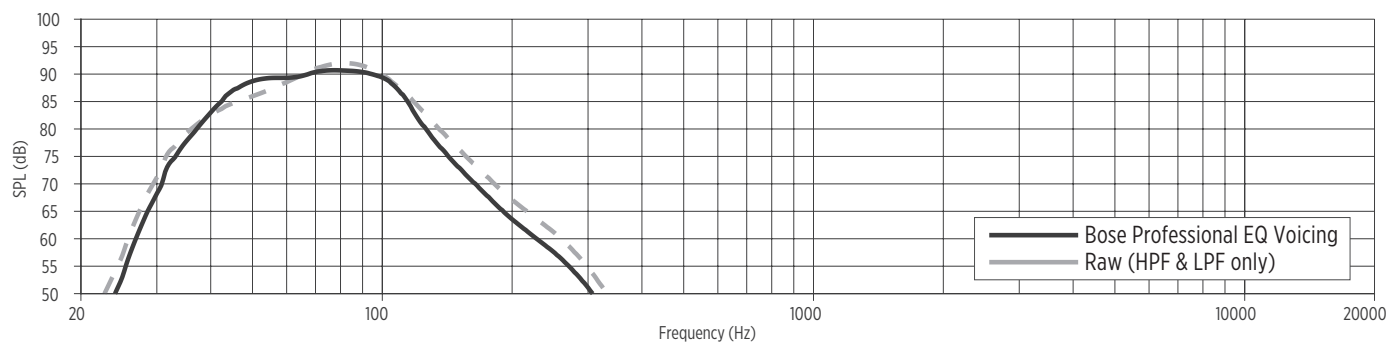

Impedance

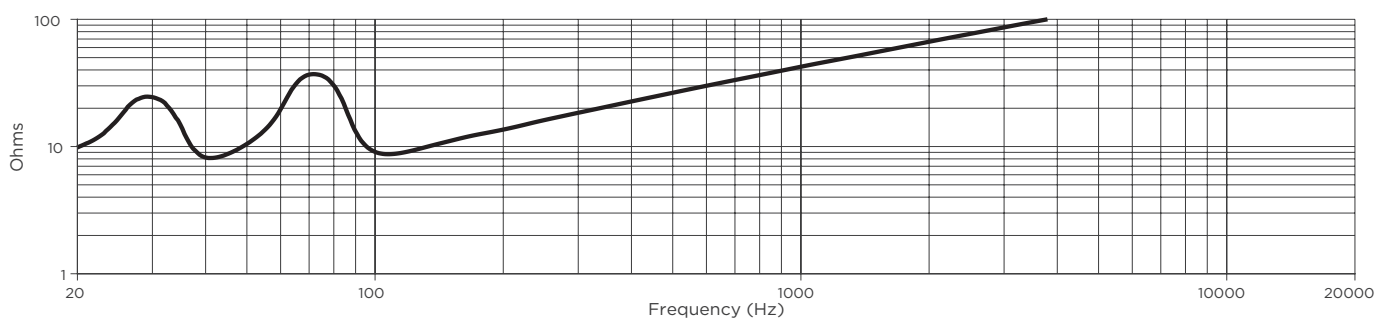

DesignMax DM10S-SUB

surface-mounted subwoofer

Dimensions

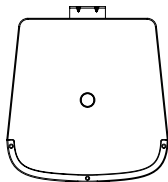

Top View
BRACKET SHOWN IN
REAR LOCATION

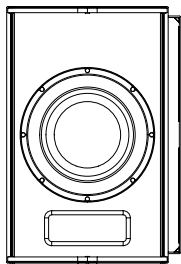
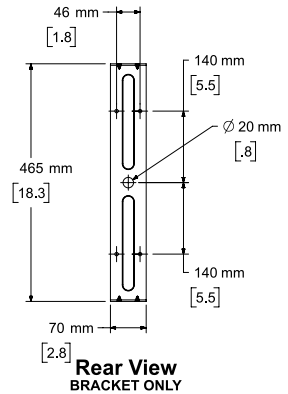
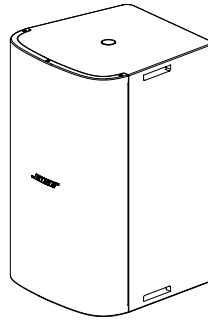

Front View
GRILLE REMOVED FOR CLARITY
BRACKET SHOWN IN
SIDE LOCATION

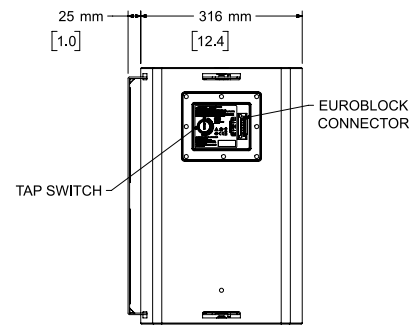
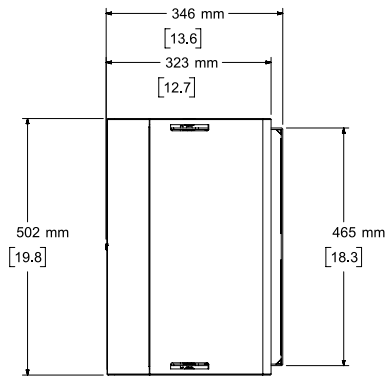

- NOTES:
1. DIMENSIONS ARE IN MILLIMETERS OVER INCHES
2. WEIGHT APPROX 16.05kg [35.40lbs] (SPEAKER ONLY)
WEIGHT W/BRACKET APPROX 16.07kg [35.45lbs]

Bose is a trademark of Bose Corporation.
DesignMax, QuickHold, and SmartBass are trademarks of Transom Post OpCo LLC.
All other trademarks are the property of their respective owners.

For additional specifications and application information, please visit BOSEPROFESSIONAL.COM.
Specifications subject to change without notice. 05/2023